

This document gives a detailed summary of the new features and modifications of FEM-Design version 15. We hope you will enjoy using the program and its new tools and possibilities. We wish you success.

Strusoft, the developers

Legend



Pay attention / Note



Useful hint



Example



Clicking left mouse button



Clicking right mouse button



Clicking middle mouse button

What's new in FEM-Design 15

- Non-linear, plastic soil calculation with real 3D soil finite elements
- Moving loads
- Documentation and Detailed result export to .docx
- Detailed result export to Mathcad and XHTML
- Soil pressure and hydrostatic pressure
- Corbel bar component
- Semi-rigid bar ends
- Insulation for foundation objects
- Improved isolated foundation
- Seismic accelerations
- List tables for RC shelled design results
- Renewed statistics dialog
- "No snap" option for layers

TABLE OF CONTENTS

1. Structure	6
1.1. Improved soil materials	6
1.1.1 Highlighted parameters according to the Foundation design/Deformation calculation they are used for	7
1.1.2 Variable soil parameters along depth	7
1.1.3 Soil material models	8
1.2. Modified soil and borehole parameters.....	9
1.3. Multiple ground water level for soils	11
1.4. New method of soil modelling	12
1.4.1 Initial Soil	12
1.4.2 Final Ground Level.....	12
1.4.3 Filling/replacement.....	14
1.5. Insulation for foundation objects.....	17
1.6. Improved Isolated foundation.....	19
1.6.1 Regular and Irregular Isolated foundation.....	19
1.6.2 Plinth.....	20
1.6.3 Replaceable Connection Point.....	21
1.7. Improved Foundation slab	22
1.8. Corbel bar component.....	23
1.9. Physical model of beams and columns.....	26
1.10. Semi-rigid bar ends	26
2. Loads	27
2.1. Soil pressure and hydrostatic pressure.....	27
2.2. Moving load	29
2.2.1 Defining a Moving load	30
2.2.2 Defining Vehicles	33
2.2.3 Summary of Moving load functions.....	34
2.3. Seismic load, NA: Norwegian defaults.....	36
2.4. Optional simultaneous plus and minus directed wind loads	36
2.5. Automatic deviation load generation option.....	37
2.6. Unlimited number of load cases, groups and combinations	37
3. Finite element mesh	38
3.1. Real 3D soil finite elements	38
4. Analysis	39
4.1. Modified Calculations and Setup load combinations dialogs.....	39

4.2.	Non-linear soil calculations	40
4.3.	Varying Ground water level by Load combinations	41
4.4.	New calculation result: Large volumetric strain	42
5.	RC design.....	42
5.1.	Shear capacity.....	42
5.2.	User-defined cot(Θ)	42
5.3.	Regular Isolated foundation.....	43
6.	Display result.....	44
6.1.	Moving load results.....	44
6.1.1	Moving load maximum.....	44
6.1.2	Moving load influence line	45
6.1.3	Moving load's cases	47
6.2.	Non-linear soil analysis	49
6.2.1	Soil plastic condition.....	49
6.2.2	Over consolidation ratio.....	50
6.3.	Seismic accelerations	51
6.4.	Insulation results	53
7.	Documentation	55
7.1.	Export to .docx format	55
7.2.	Export to Mathcad and to XHTML	58
7.3.	New and modified Lists	60
7.3.1	Moving load results	60
7.3.2	RC shell design results	61
8.	CAD/User interface	62
8.1.	"No snap" option for layers	62
8.2.	More comfortable 2D and 3D view definition	63
8.3.	Copy from Used material/section to Library	64
8.4.	Calculation dialog staying open	64
9.	Tools.....	65
9.1.	Renewed Statistics dialog	65

1. STRUCTURE

1.1. Improved soil materials

In FEM-Design 14 the Library material dialog, where User can specify soil materials, contains two separate tabs for Deformation and Strength properties. In FD 15 all these properties can be found in the same place. Furthermore, the renewed Library Material dialog offers even more opportunity:

- highlighted parameters according to the Foundation design/Deformation calculation they are used to
- variable soil parameters along depth
- three different soil material models

In FD 14

In FD 15

Set the behaviour of the soil material

Check to use both Drained and Undrained behaviour

Choose Material model type

Parameter	Value	d
c uk [kN/m2]	130	0.000
c k [kN/m2]	120	0.000
phi k [deg]	45.0	
phi cvk [deg]	36.0	
Gamma dry [kN/m3]	16.0	
Gamma sat. [kN/m3]	18.0	
M0 [kN/m2]	2500	0.000
E [kN/m2]	1857	0.000
nu	0.300	

1.1.1 Highlighted parameters according to the Foundation design/Deformation calculation they are used for

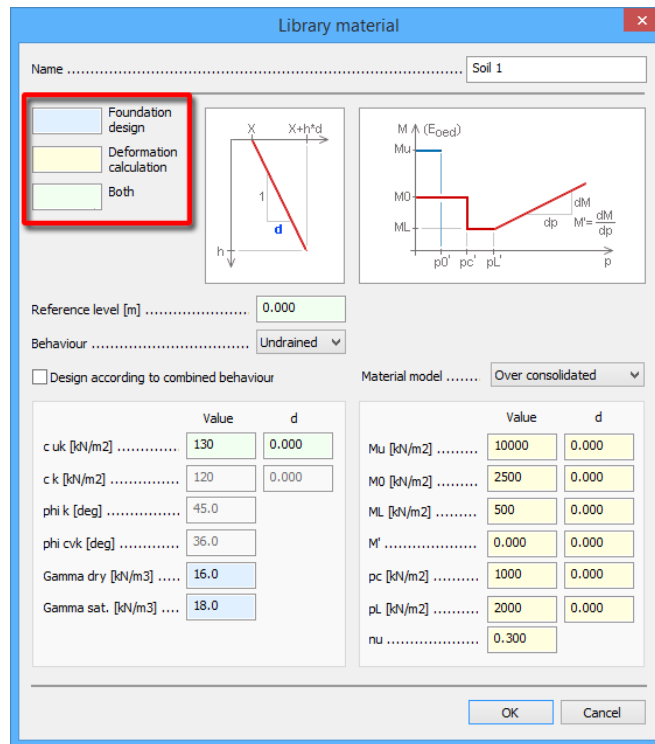

In the new Library material dialog the background of the soil parameters are coloured depending on the calculation(s) they are used for.

1.1.2 Variable soil parameters along depth

Depth dependent increment of parameters of soil materials (e.g. $c_{u,k}$, c_k , M_0 , etc.) can be set in the Library Material dialog. Firstly, the reference level should be set, which applies for all parameters. Secondly, User has to set the increment rate of each parameter (d)

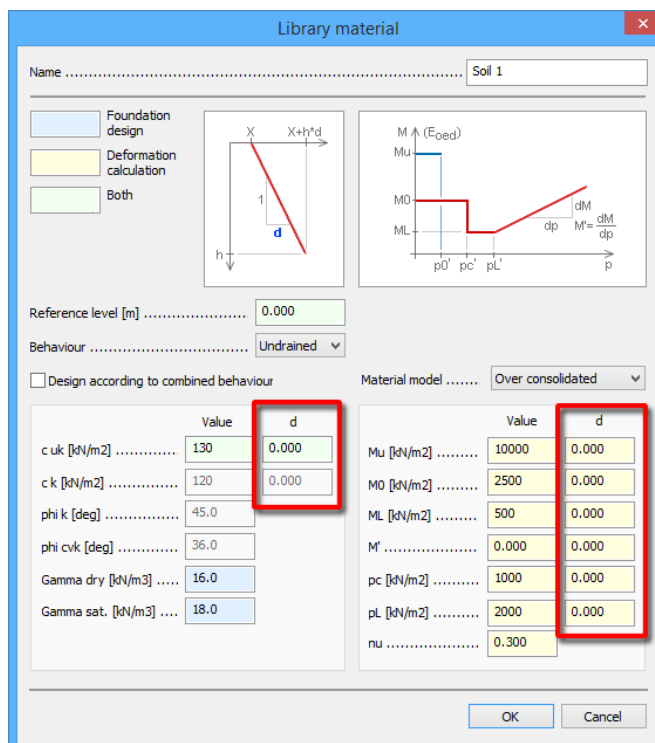

Above the reference level the value of a variable parameter in the soil will be constant, equal to the one given by User in the Value column. Beneath this level it will be calculated as a linearly variable parameter, depending on the depth from the reference level.

 The Reference level is always considered in the global Z axis and it is parallel to the global X-Y plane!

1.1.3 Soil material models

In the renewed Library material dialog three types of material models can be selected:

- Linear
- Over-consolidated
- Generic

Linear soil material models can be determined by the E Young-, or the E_{oed} compression modulus. For further information about the material models see in [3D Soil theory manual](#)

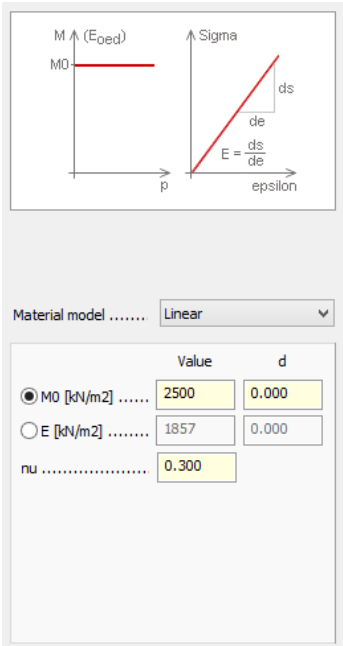

With the Over-consolidated option a special non-linear material model can be defined. The relation between the M₀ and E is the following:

$$M_0 = \frac{E(1-\nu)}{(1+\nu)(1-2\nu)}$$

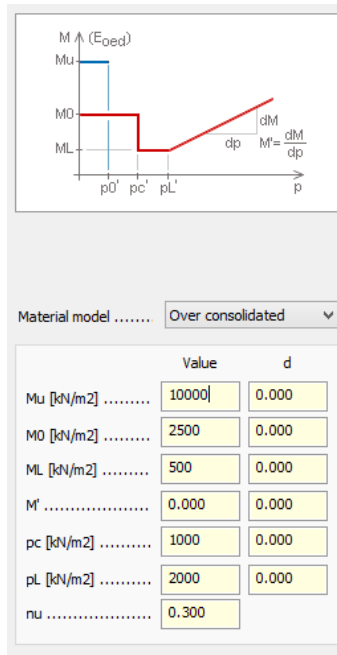

With the Generic option User can fully customize non-linear soil material models by defining each segment of the p' - M graph and the rate of increment for the parameters (see more in paragraph 1.1.2).

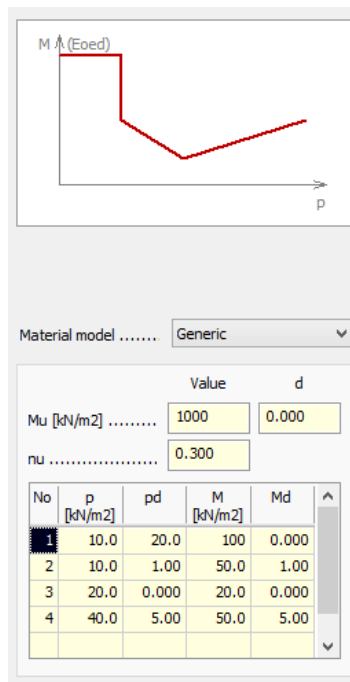

1.2. Modified soil and borehole parameters

A new tab called Ground water is added to the Soil dialog and the Borehole dialog. (For more details see paragraph 1.3)

On Borehole/General tab the Foundation level can no longer be set, since FD 15 matches it to the Soil object automatically.

Further changes are described in paragraph 1.4.

Soil

A.1 General Strata Ground water

Identifier SOIL

Limit depth level [m] -10.00

Default filling repl. soil > [color swatch]

Solid finite elements

Average element size [m] 2.000

OK Cancel

Borehole

A.1 General Strata Ground water

Identifier (.position number) BH1

Final ground level [m] 0.0000

OK Cancel

1.3. Multiple ground water level for soils

It is possible to define more than one ground water surface for the soil object. Different ground waters can be set for each Load combinations, as shown in paragraph 4.3.

In the Soil dialog/Ground water tab User can define the GW-s as it is shown below:

Double click on the first empty row to specify a new GW

No	Name	Colour
1	GWL 1	Blue
2	GWL 2	Purple
3	GWL 3	Cyan

Click to insert new GW above the selected one

Click to delete selected GW

The level of each ground water can be set in all boreholes separately.

Double click to change level of certain ground water in the selected Borehole

No	Name	Level [m]
1	GWL 1	-3.00
2	GWL 2	-5.00
3	GWL 3	-9.00

Soil surface

GW 1 level

GW 2 level

GW 3 level

Limit depth level

1.4. New method of soil modelling

FD 15 gives User new tools to define soil objects even more precisely. Therefore, the method of creating them changed, and has two basic steps now:

- creating the Initial Soil object: this is the definition of the regular soil object for initial stresses
- setting up the Final Soil object: includes all modifications performed on the Initial Soil

The exact procedure is shown below.

1.4.1 Initial Soil

Definition of the Initial Soil is similar to the definition of the regular Soil object in the earlier versions. The difference is the two new parameters in the Soil dialog:

- Default Filling: the Soil material, which will be used to create Filling when final ground level is higher than the original ground level and User does not specify other filling
- Average element size: the mean size of the finite elements of the soil, if “Calculate soil as solid element” is active (see more at paragraph 3.1.)

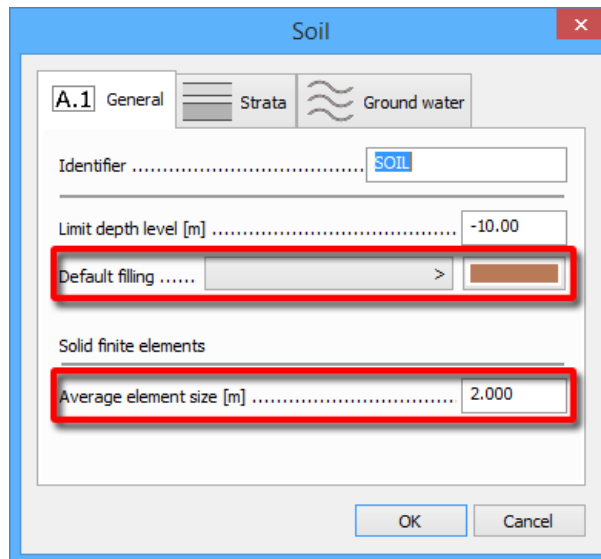

1.4.2 Final Ground Level

There are two ways to set the Final Ground Level in FEM-Design 15.

Firstly, in the modified Borehole dialog for each Borehole.

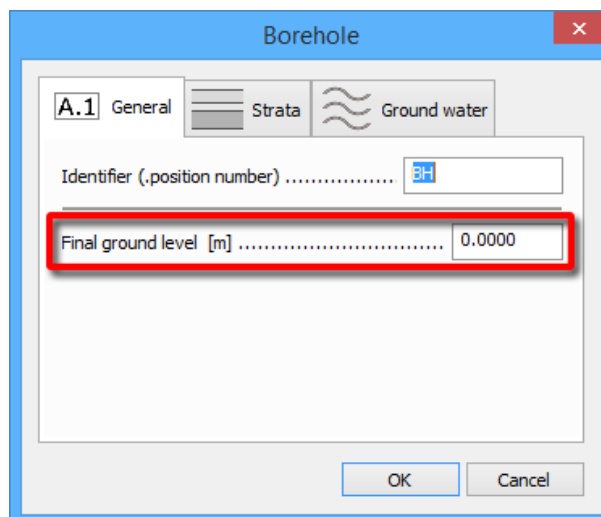

Secondly, User can define a new, simplified subtype of boreholes, the Final Ground Level object. This borehole has only one parameter, with which the top level of the Final Ground Object can be set in a certain point.

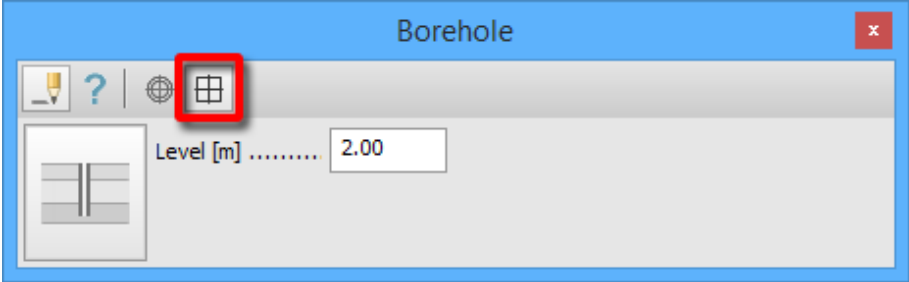

The next figure shows the definition method of the Final Ground Level object.

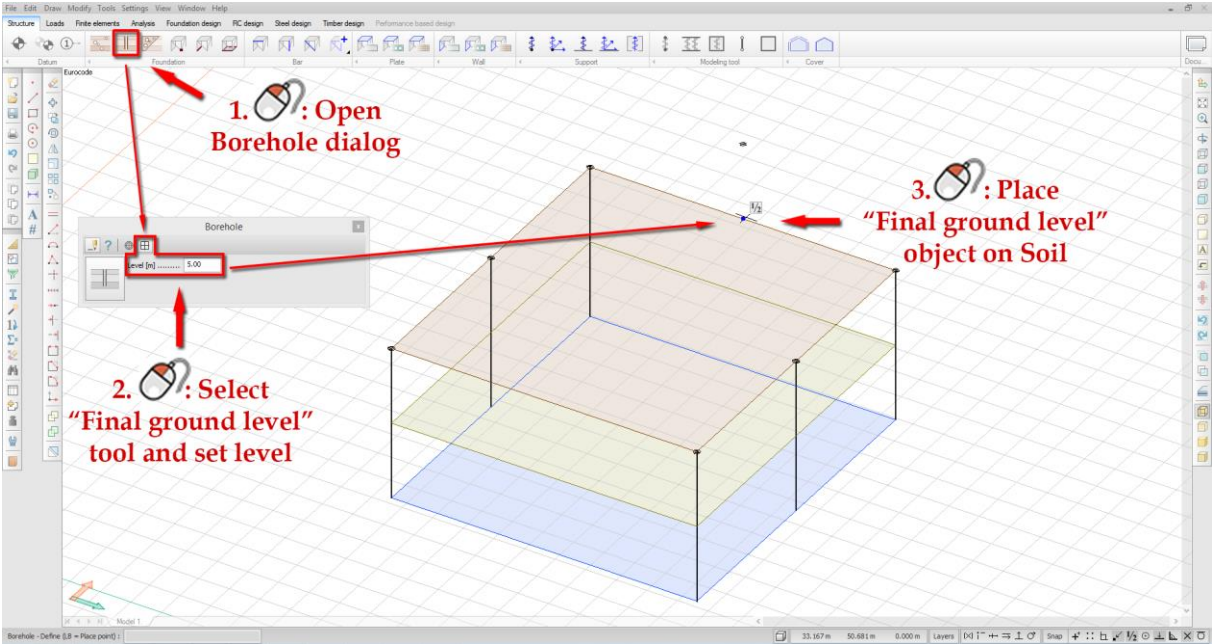

It is recommended to use the Plane View of the model while creating Final Ground Level objects.

Where the Final Ground Level is above the top level of the Initial Ground object, FD applies the Default Filling soil in the model. Where it is beneath, the soil will be removed from above the Final Ground Level.

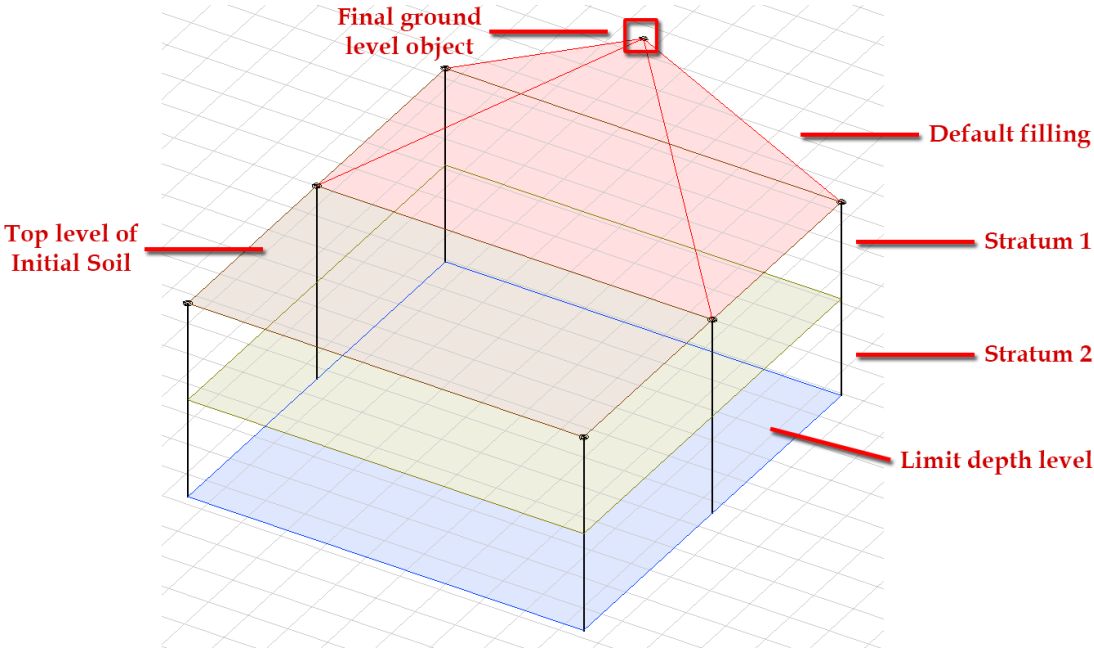

1.4.3 Filling/replacement



With this new object User can create

- Fillings with customizable soil (different from Default filling)
- Replacements: individual regions of the Final Soil object, where the Soil Material and/or the strata conditions are different from the Initial Soil.

The Region tool

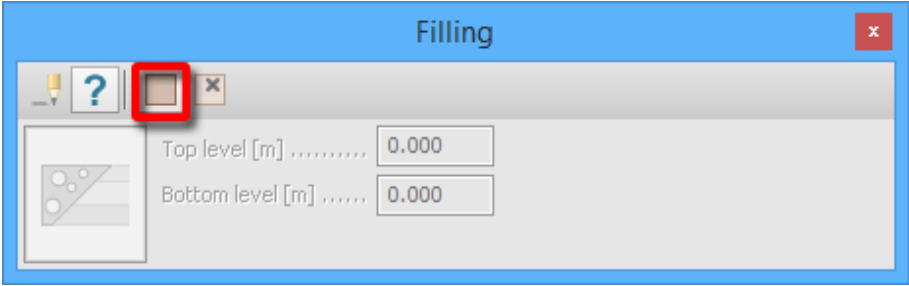

Filling/replacement object can be defined with the Region tool, following the method below:

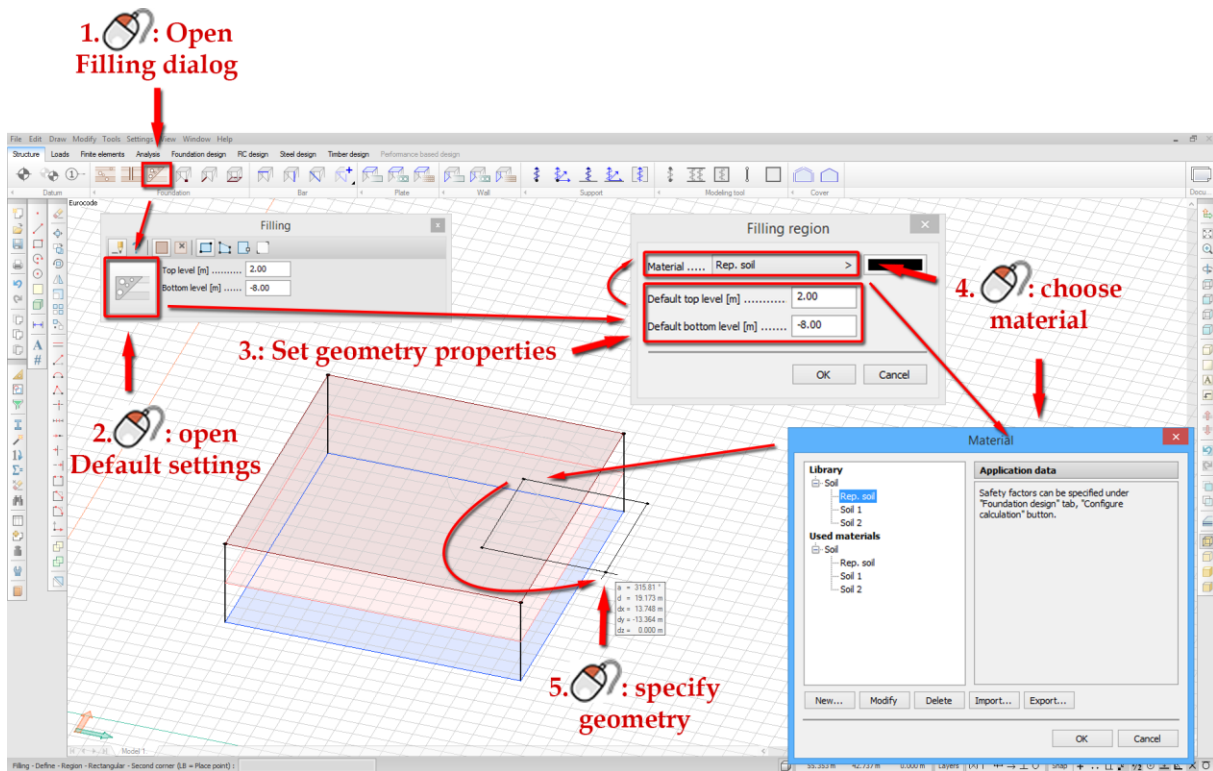

Based on the position of the Filling/replacement object, three regions of it can be distinguished according to the changes FD will consider in the Final Soil:

- regions overlapping the Default filling (above the Initial Soil) will be replaced with the User-specified soil material
- regions overlapping the Initial Soil will be replaced with the User-specified soil material (irrespective of strata conditions)
- regions outside the Initial Soil and the Default filling at the same time will be ignored in the calculations (shown in the next figure)

With active Structure tab

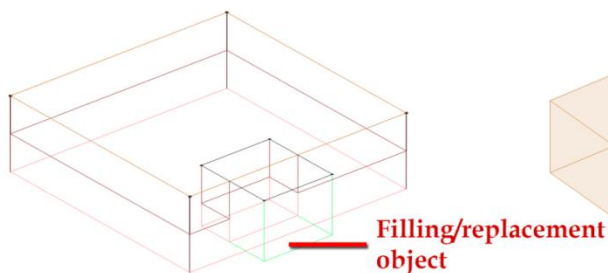

With active Analysis tab

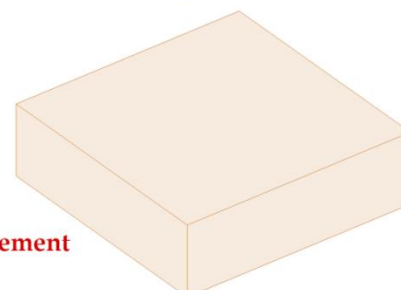
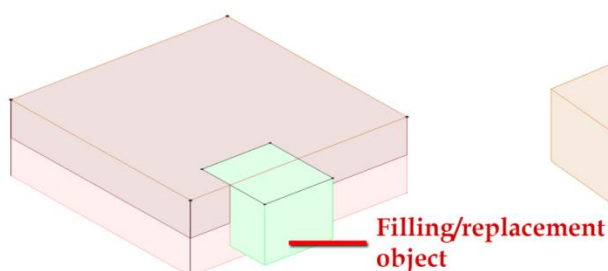
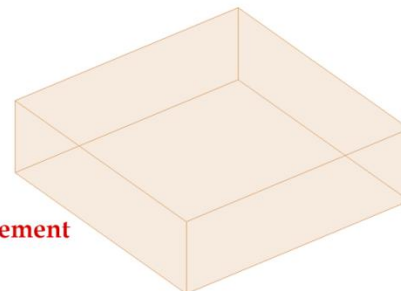

Level point tool

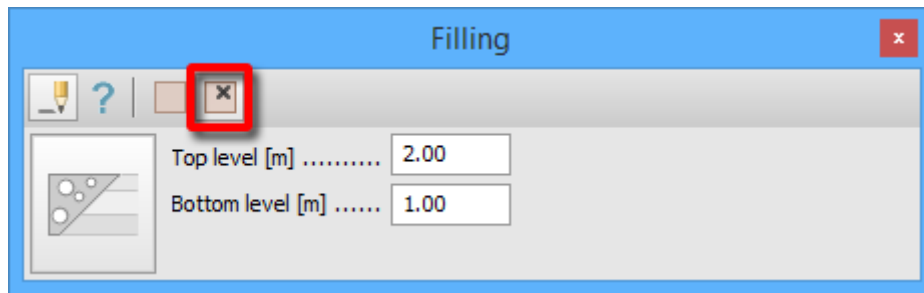

With the Level point tool User can create new or redefine existing Level points (marked as "X") on certain Filling/replacement objects, with which he/she can customize its shape.

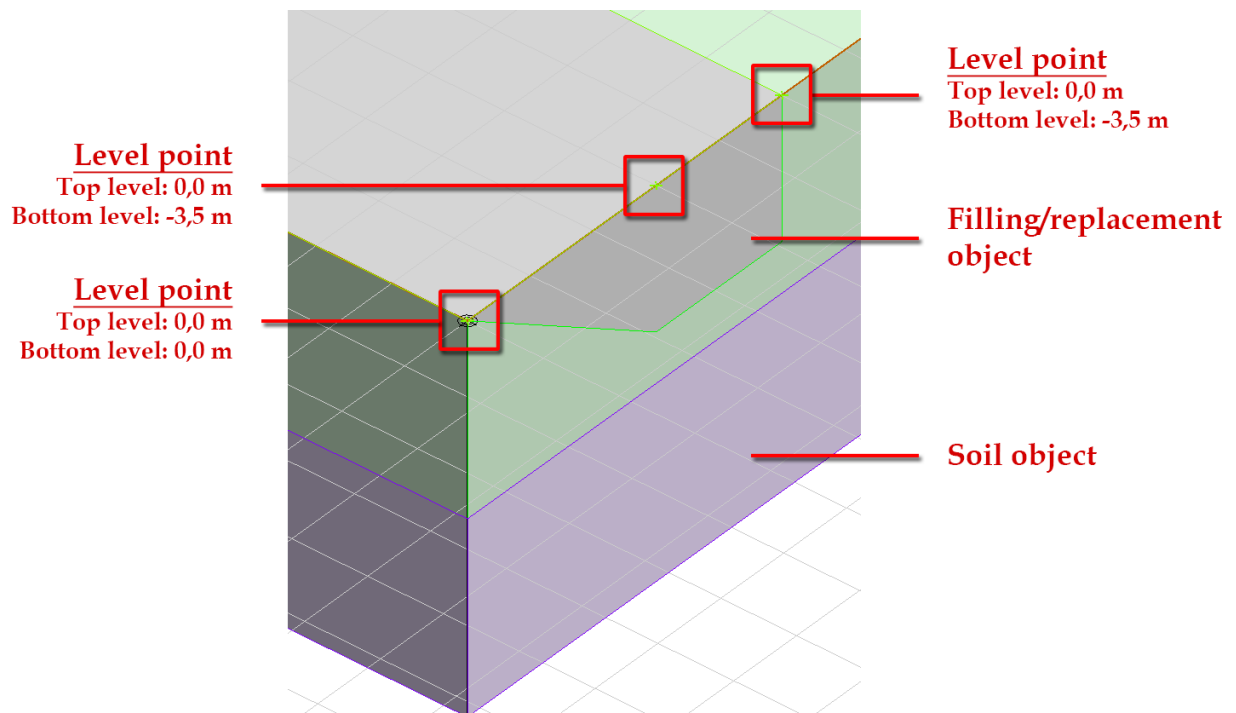

1.5. Insulation for foundation objects

Insulation can be attached to foundation objects modelled as a surface-surface connection.

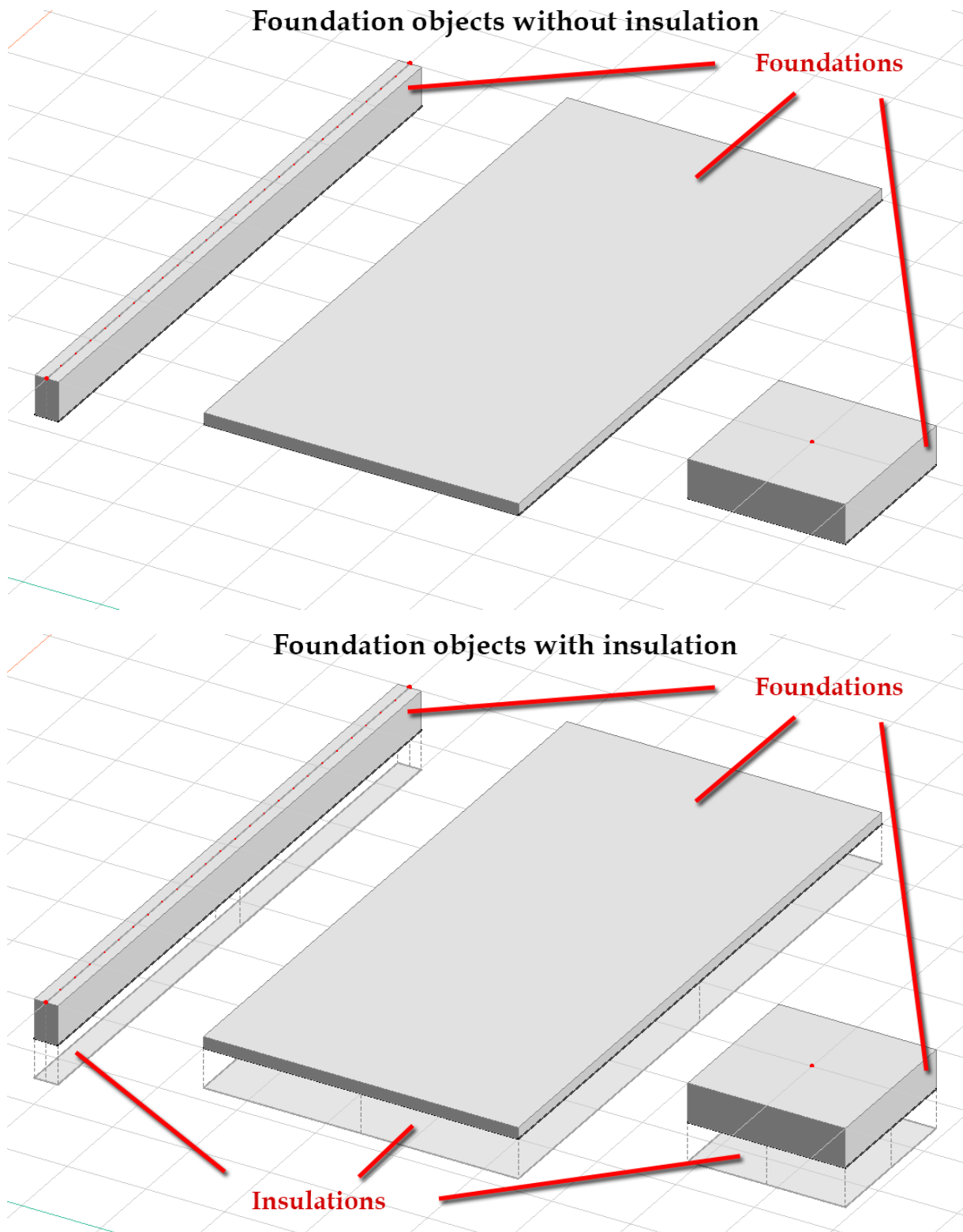

This option can be accessed in the following dialogs:

- Foundation slab
- Wall foundation
- Isolated foundation

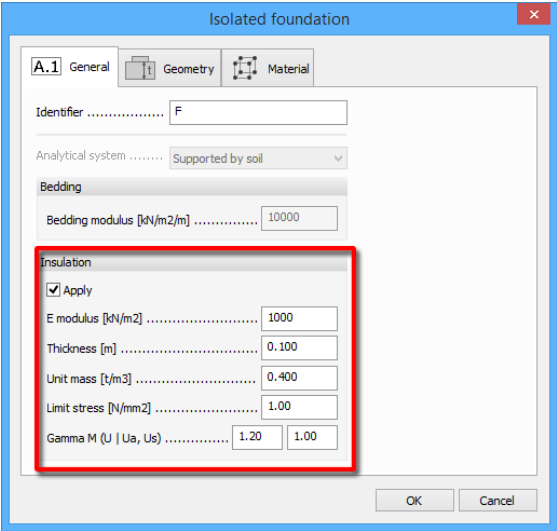
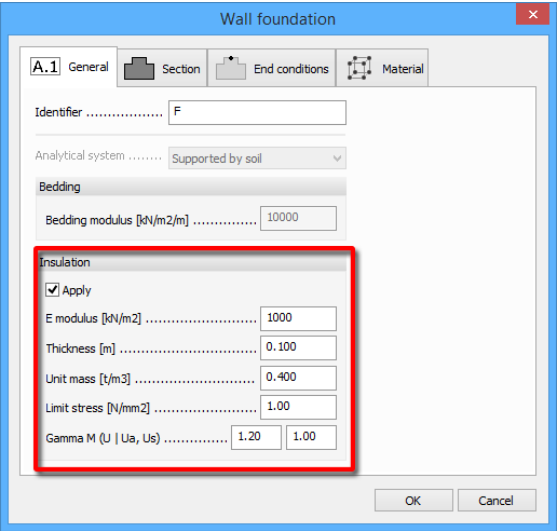
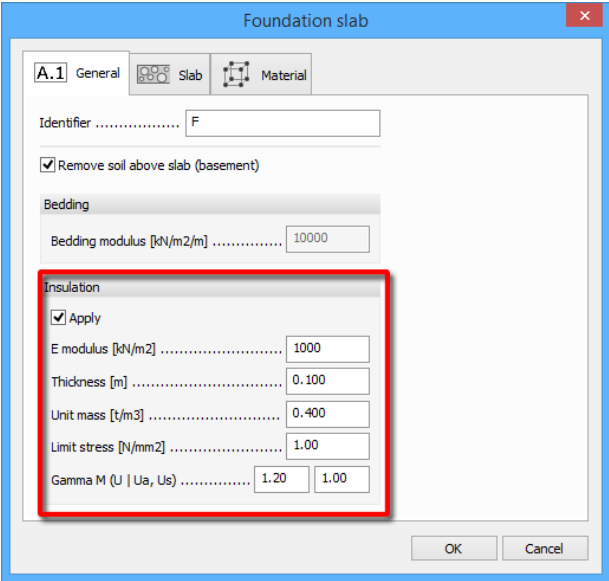



FEM-Design 15 is able to execute stress-based check of Insulations. To this end, User can set the limit stress and the safety factors, too.

See more about the results in paragraph 7.4.

1.6. Improved Isolated foundation

1.6.1 Regular and Irregular Isolated foundation

In FD 15 User can define two types of Isolated foundation: Regular  and Irregular . The Regular is the usual foundation object with the same definition method as in FD 14.

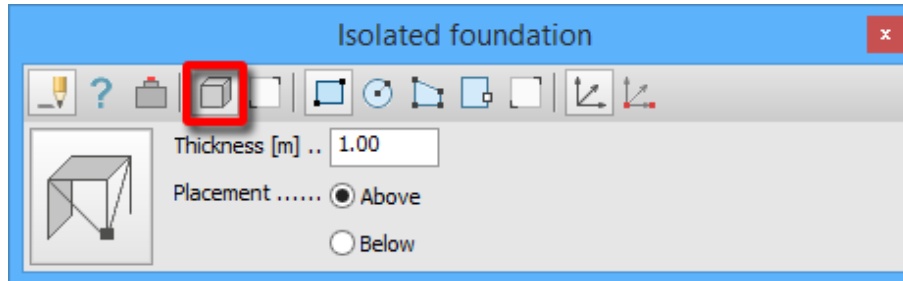

User can set its properties in the Isolated foundation dialog, which has three tabs:

- General: contains the identifier, analytical system, bedding and insulation settings
- Geometry: geometry setting, such as thickness and plinth properties
- Material: the usual Material tab

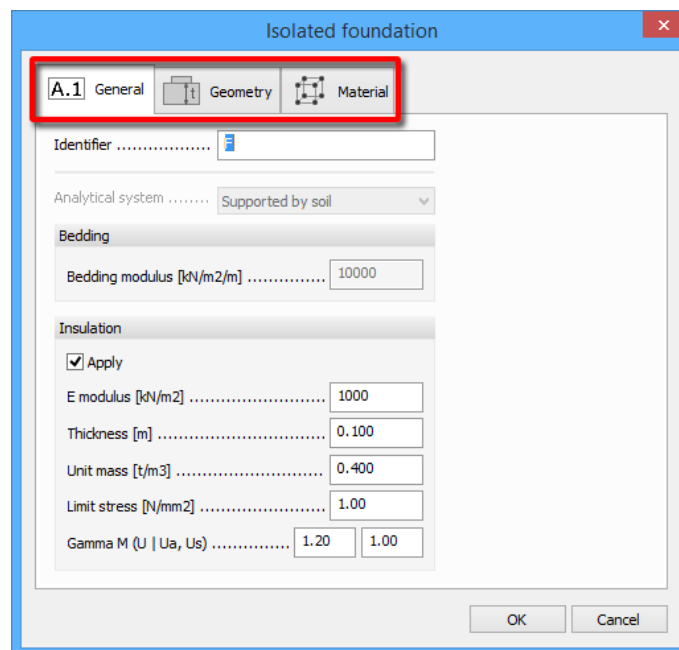

The Irregular Isolated foundation can be defined with the “Shape by selection” tool from an existing Solid drawing object, by the following easy steps:

- activating “Shape by selection” tool
- determining Default settings
- selecting existing Solid drawing object
- (defining the Local x' axis with start point and end point, if the  “Edit local x' direction ” is active)
- specifying Connection point on the bottom surface of the Solid

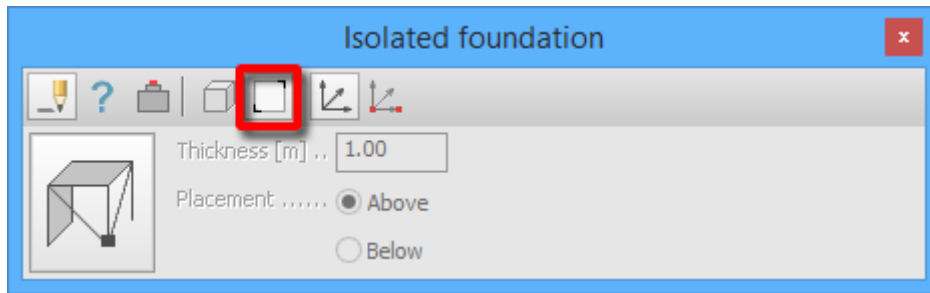

Irregular Isolated foundation object has the same properties as Regular with the exception that the thickness can't be set and Plinth can't be defined for it. User can attach Insulation to the bottom surface of the object, too.

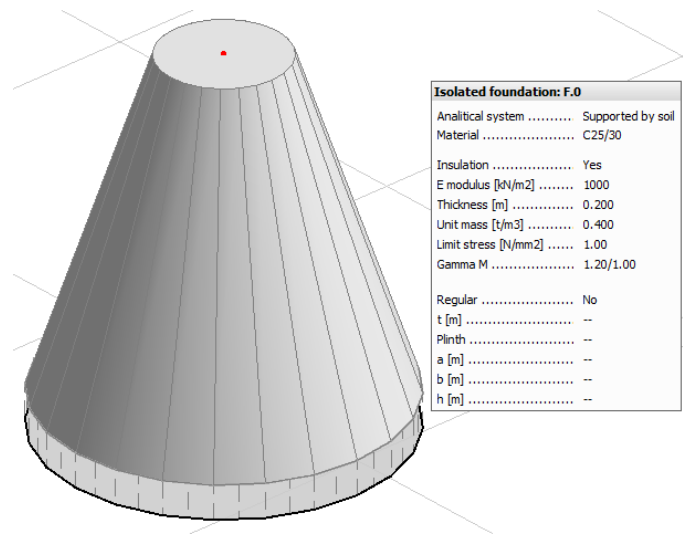

1.6.2 Plinth

In the new Geometry tab of the Isolated Foundation dialog User can define a Plinth for the Regular type of Isolated foundations.

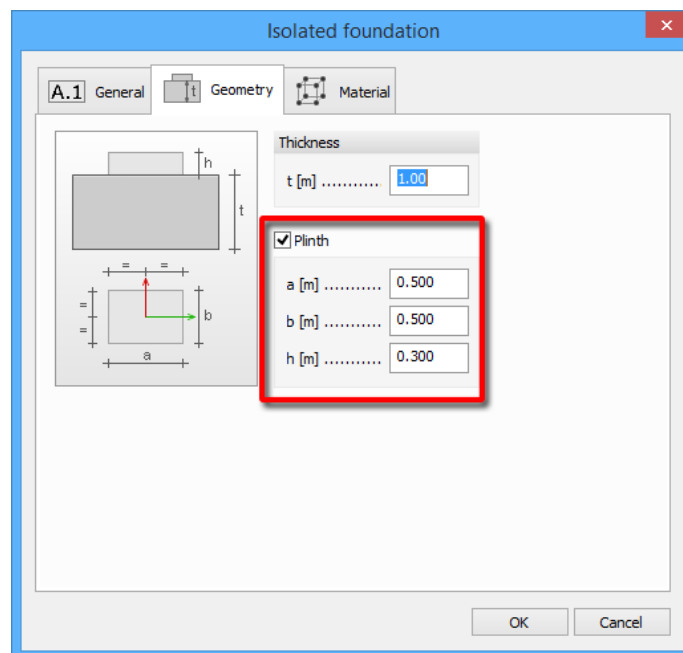

This object will be attached to the top side of the Isolated Foundation object, and its Local Coordinate System's origin is always the Connection Point of the foundation. The foundation and its Plinth will be considered as one homogeneous object in the calculations.

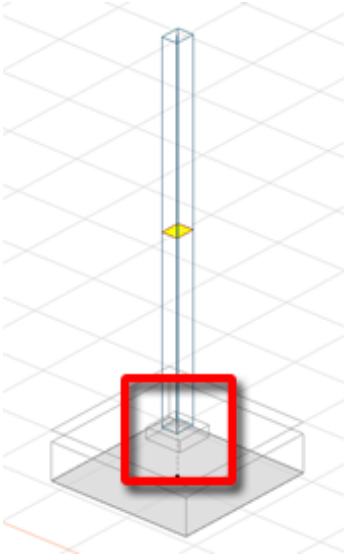

As it can be seen in the figure above columns join to the top of the Plinth.

1.6.3 Replaceable Connection Point

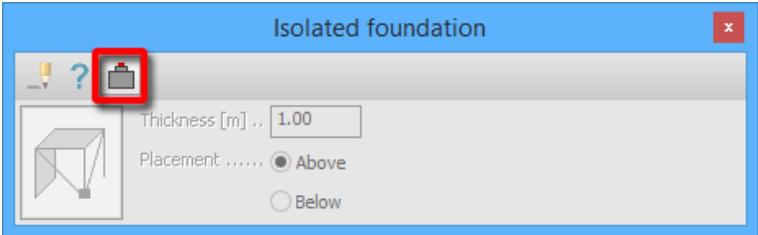

With the new Connection point tool in the Isolated foundation dialog User can move the Connection Point on an existing Isolated foundation object anytime. Moving it will also replace the Plinth (but not the attached column), if it is applied.

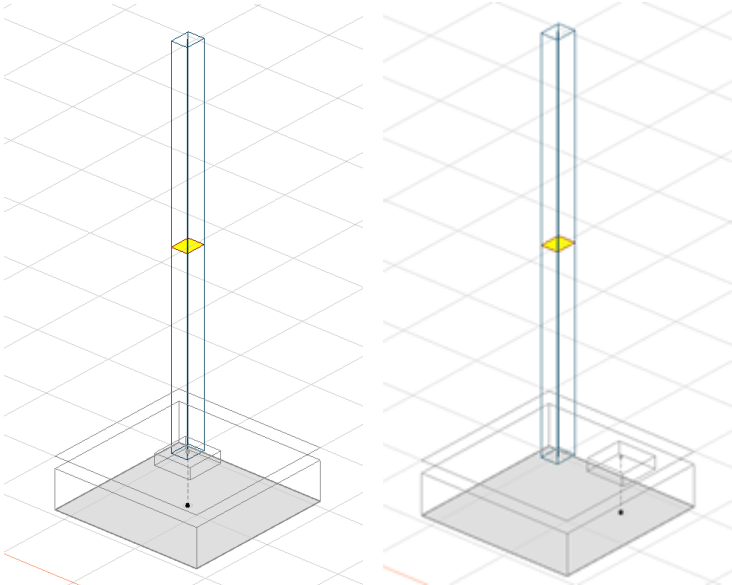

1.7. Improved Foundation slab

For a clear overview Foundation slab properties are sorted in three tabs:

- General: preferences of the bedding, insulation and space for basement
- Slab: containing the settings of the slab geometry
- Material: the regular Material tab

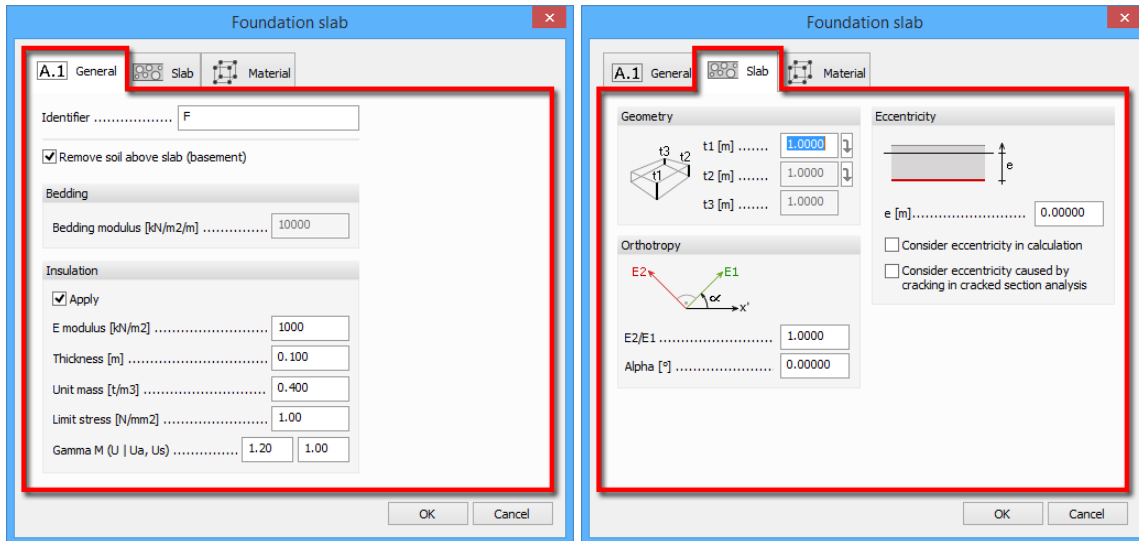

Designing a structure with basement requires no time-consuming modifications of the Soil object in FD 15. If the “Remove soil above slab” checkbox is active in *Foundation slab/General* tab, the program cuts out the part of the Soil object above the Foundation slab. Furthermore, it creates Surface connection objects on the new bounding surfaces of the Soil object.

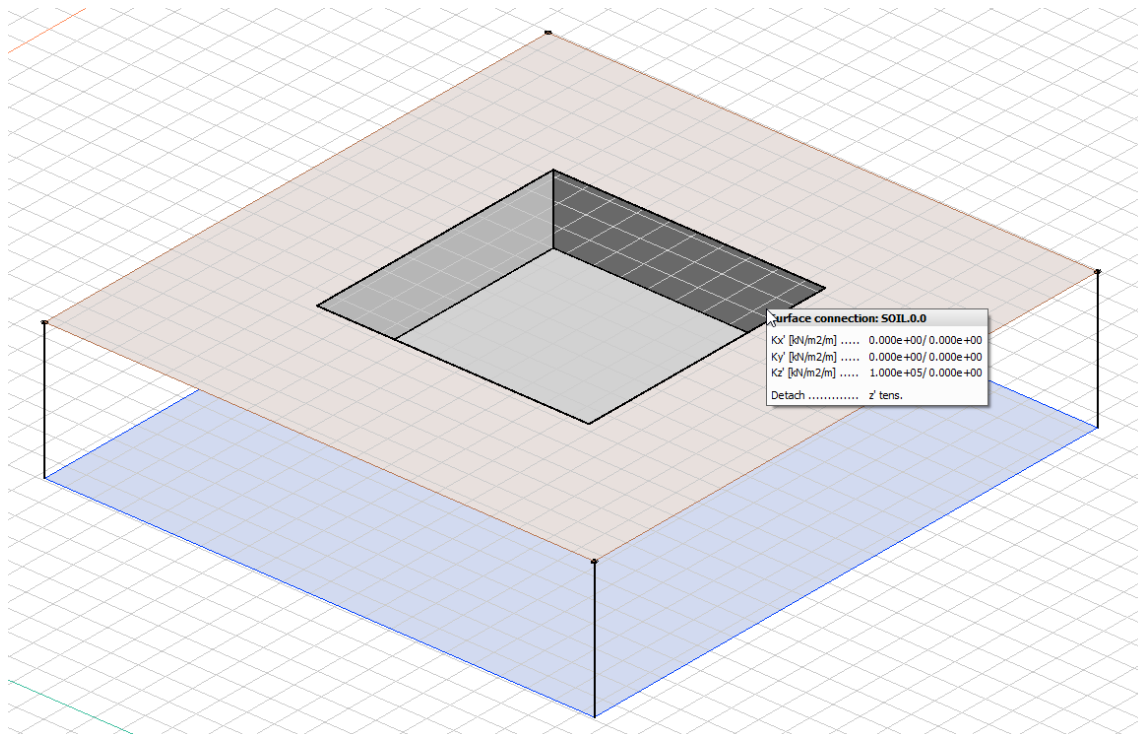

The created connections can transfer compressions only and they cannot be modified!

Thickness of foundation slabs can be modified with the  Variable thickness tool or in the Foundation slab dialog. The method is the same as for the Plate structure objects with one exception: the alignment of a foundation slab cannot be changed (it is permanently set to bottom).

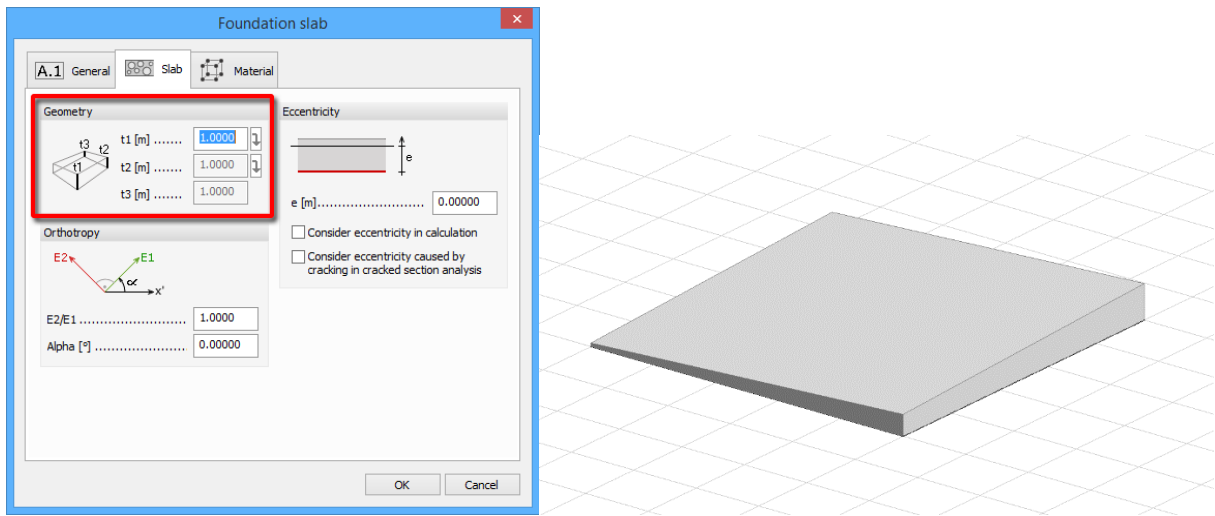

1.8. Corbel bar component

A new object, the Corbel is added to the Bar components. User can use it to apply short consoles attached to columns.

A Corbel is always perpendicular to the local X axis and parallel with the local Y or Z axis of the column. It has a rigid connection at the start point. The end condition at the end of the Corbel matches to the connected beam.

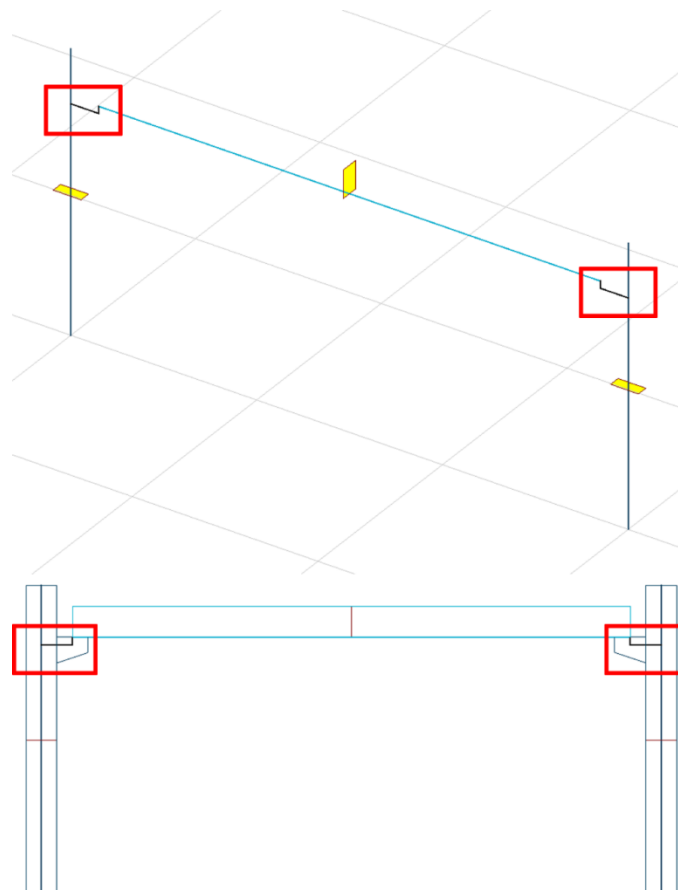



Using Corbels User can avoid the time-consuming task of manual modelling of eccentric connections.

User can define a Corbel by following the steps in the next figure:

1. : Select Corbel in Bar component menu

2. : Set the direction of the Corbel

3. Set properties

4. : Select position of the Corbel along the column

The screenshot shows the software interface with the Corbel dialog box open. The dialog box has three tabs: General, Section, and Material. The General tab is active, showing the Identifier (.position number) as 'CO'. Under the Geometry section, there are two diagrams: one showing the orientation of the corbel with angles 90°, 180°, and 270°, and another showing the dimensions d, l, e, x, and y. The Alpha dropdown is set to 0.000. The checkbox 'Automatically adjust "d" to bounding rectangle of column' is checked. The dimensions are: d [m] = 0.200, l [m] = 0.300, e [m] = 0.000, x [m] = 0.150, and y [m] = 0.000. The OK and Cancel buttons are at the bottom right.

The Corbel dialog has three tabs. In the General tab User can specify the followings:

- direction of the Corbel
- relative position of the Corbel compared to the column (d, e)
- length of the Corbel (l)
- position of the load application point (x, e), marked with red dot in the figure below
- whether to calculate the “d” value automatically in accordance with the Section of the column or not

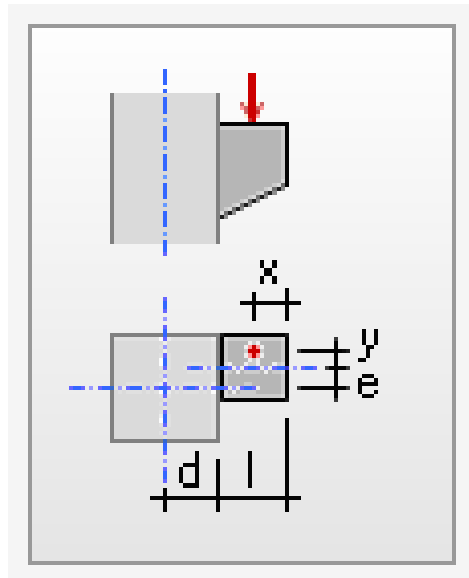

The other two tabs are the regular Section and Material tabs.



Connecting beams to the Corbel in the proper way is crucial. It is significant to consider that the analytical and the physical end of the Corbel are not coincident.

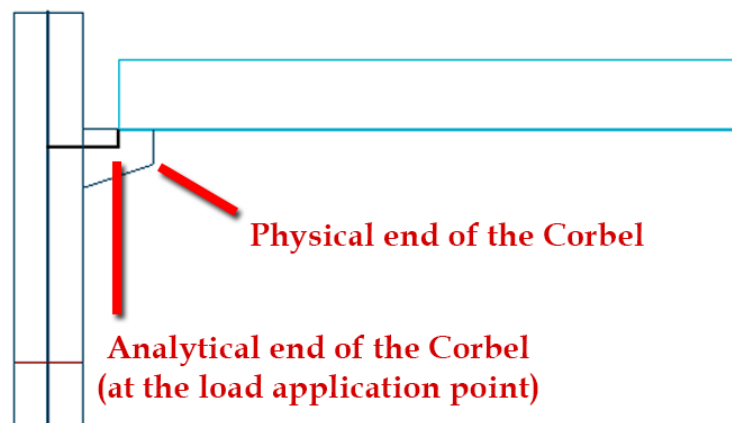

1.9. Physical model of beams and columns

Eccentricity of the analytical and the physical model is separated in FD15. In the “End condition” tab eccentricity of the analytical model can be set as in earlier versions. Eccentricity of the physical model can be set in the new “Physical model” tab, in a similar way.

At the same time, considering analytical eccentricity in calculations is no longer optional.

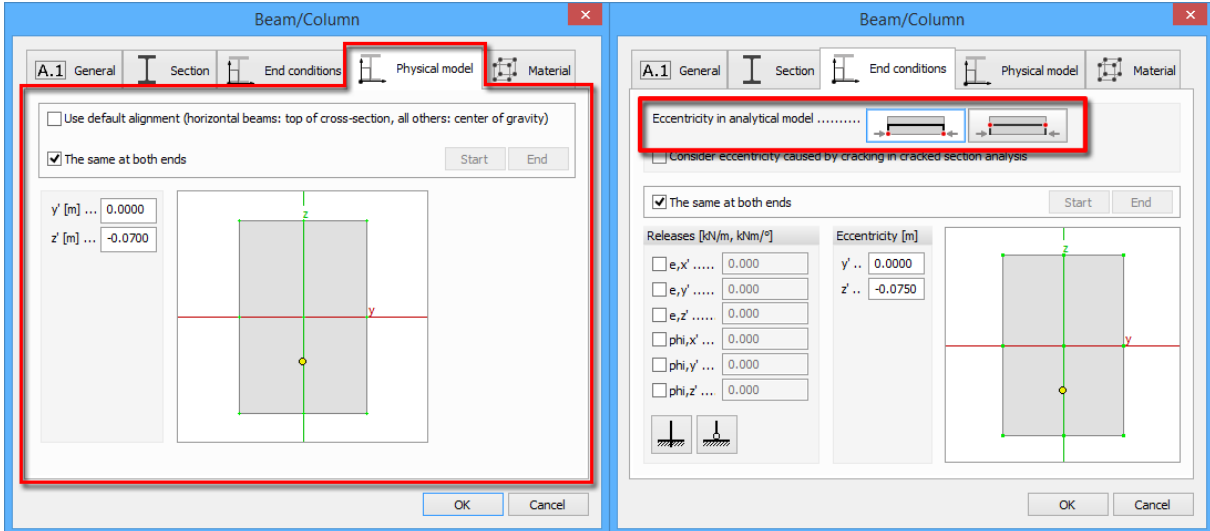

1.10. Semi-rigid bar ends

Semi rigid bar ends can be set in the Beam/Column dialog. Compared to the FD 14 version not only the releases can be defined but also the exact rigidity for all displacement components separately.

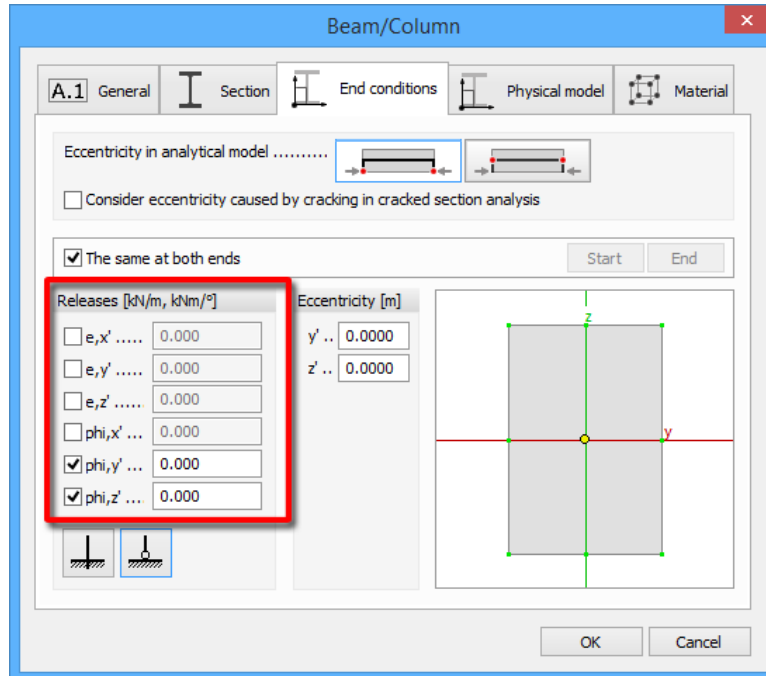

2. LOADS

2.1. Soil pressure and hydrostatic pressure

As a new type of surface load Soil/hydrostatic pressure can be defined in FD 15. In the Surface load dialog two type of surface loads are available now.

Pressing the “Ordinary” button allows the user to specify usual surface loads, as in FD 14.

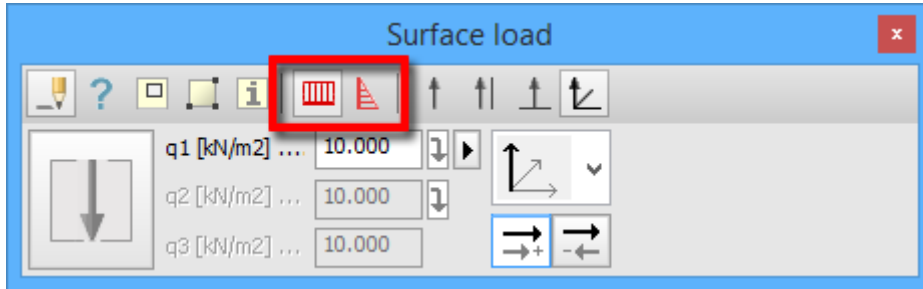

With “Soil/Hydrostatic pressure” button linearly variable loads can be defined.

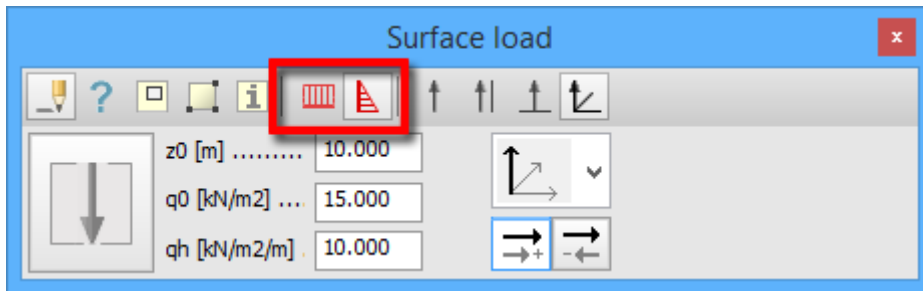

These loads are automatically calculated based on three user-defined values:

- z0: the surface level of soil/water (on the global Z axis)
- q0: the intensity of load at the surface level
- qh: the increment of load intensity (along the global Z axis)

The intensity of the load at a certain point of an element is calculated with the formula below:

$$q = q_0 + (z_0 - z) \cdot q_h \quad (2.1.)$$

q: the intensity of the load at the particular point

z: the Z coordinate of the point

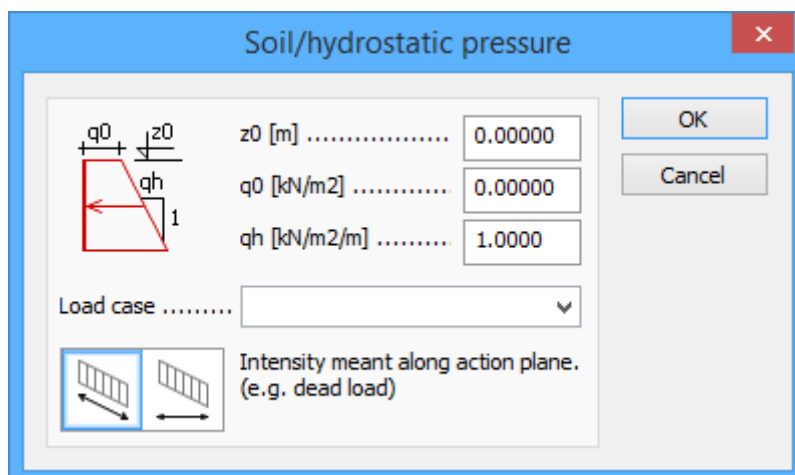

The direction of the soil/hydrostatic pressure load can be determined in the same way as the direction of the surface load in FEM-Design 14.

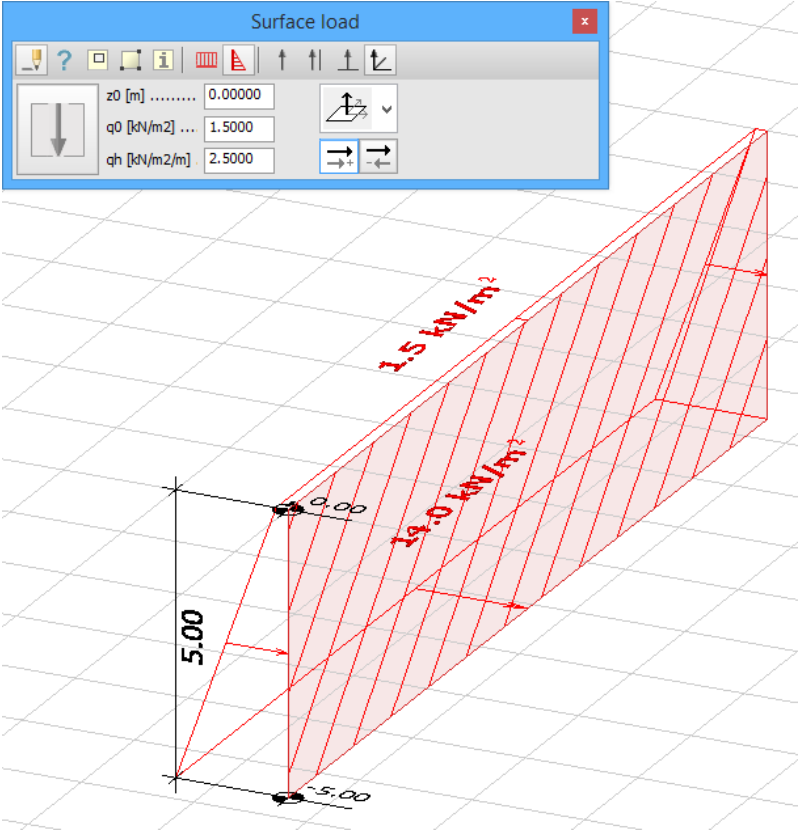

 For the fastest and easiest load definition it is recommended to use the “Direction is parallel with the local z’ axis” option.

2.2. Moving load

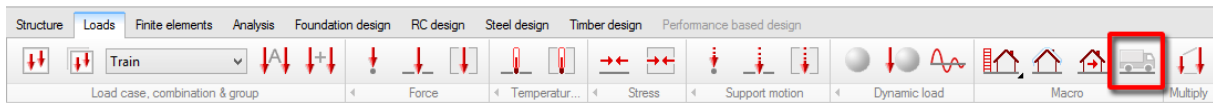

The Moving load macro applies a pre-defined set of loads (Vehicle) along a user-specified path. Its working method is the following:

1. User specifies the path and the preferences of the Moving load.
2. The macro defines Vehicle positions along the path according to the preferences.
3. The pre-defined Vehicle is added to each Vehicle position, producing singular Load cases.
4. A Load group is created, containing the Load cases of the Moving load.

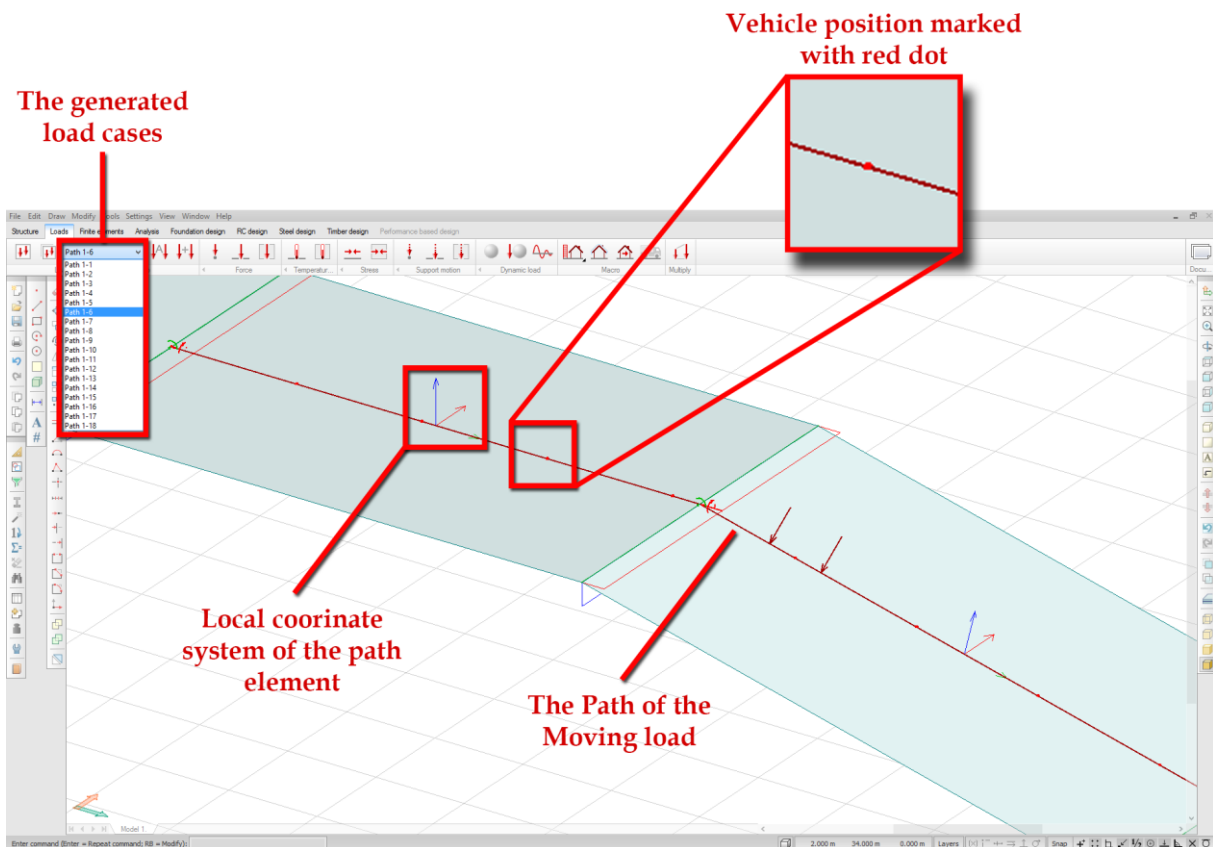

2.2.1 Defining a Moving load

The following figure shows the definition method of a Moving load:

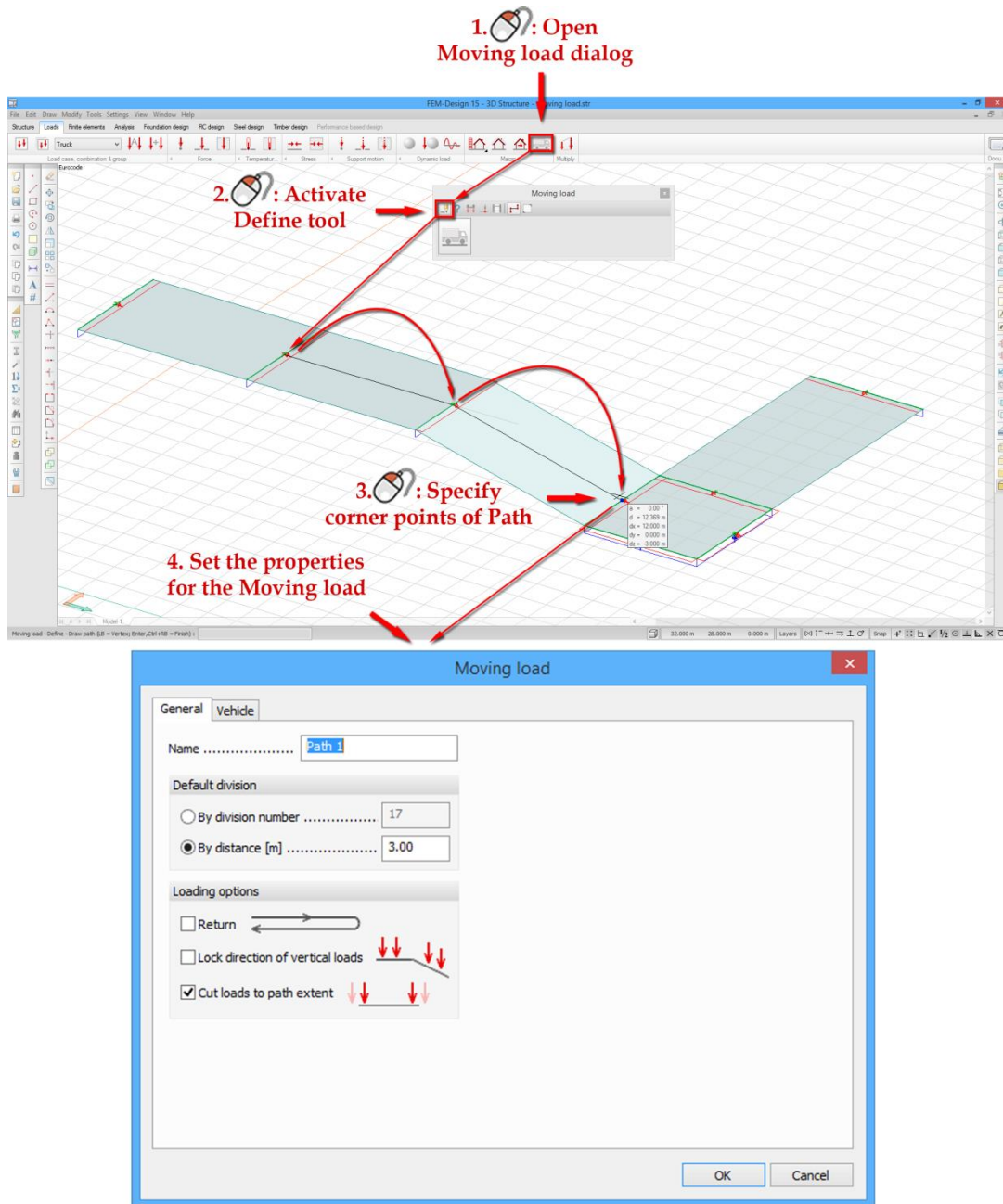

The options on the General tab are described below.

Default division: the method how the path of the Moving load is divided into segments. The Vehicle positions will be defined in the points of division and at the start and the end point. The division can be defined

- By division number: the number of parts, that the macro divides the Path into, will be equal with the given value. Accordingly, the result is one more Vehicle position than the user-specified value. The distance between the points of division (and therefore between the Vehicle positions) are equal.

- By distance: the software defines as many segments from the start of the Path, with length equal to the specified value, as possible. The last segment may be shorter than the others.

Loading options: the preferences of the way the macro defines the individual load cases along the path.

-  Return: if checked, two load cases are defined in each Vehicle position. The first one has the same X axis direction as the Local coordinate system of the path element its Vehicle position is located on. The second one has the opposite X axis direction.

Vehicle placed with the same X axis direction as the path element (LCS)

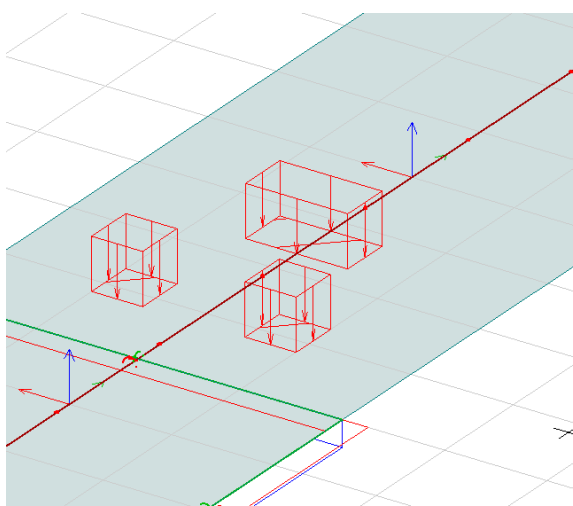

Vehicle placed with X axis direction opposite to the path element (LCS)

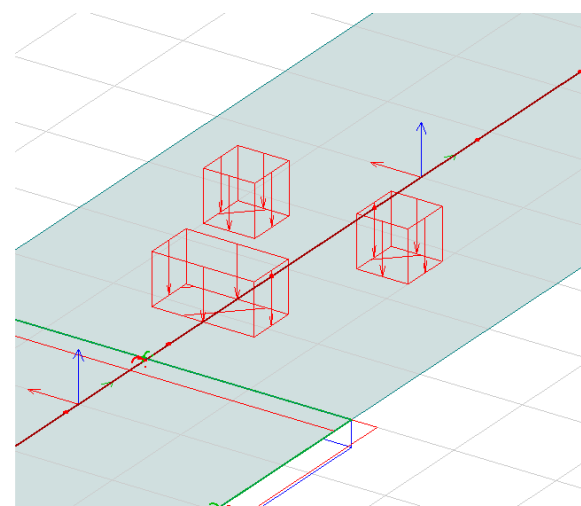

-  Lock direction of vertical load: if checked, the vertical loads of the selected Vehicle are forced to be parallel with the global Z axis. Otherwise, they are parallel with the Z axis of the Local coordinate system of the path element which they are located on.

Load case without locked direction of vertical load

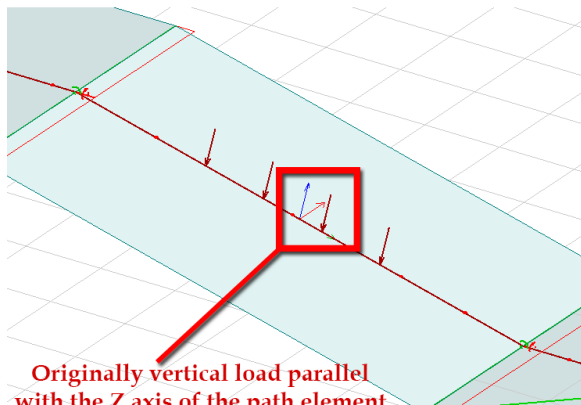

Originally vertical load parallel with the Z axis of the path element

Load case with locked direction of vertical load

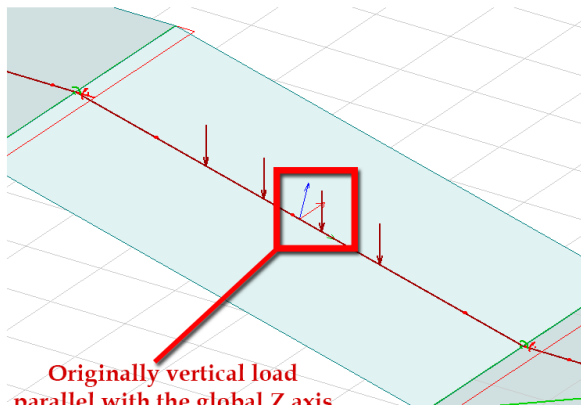





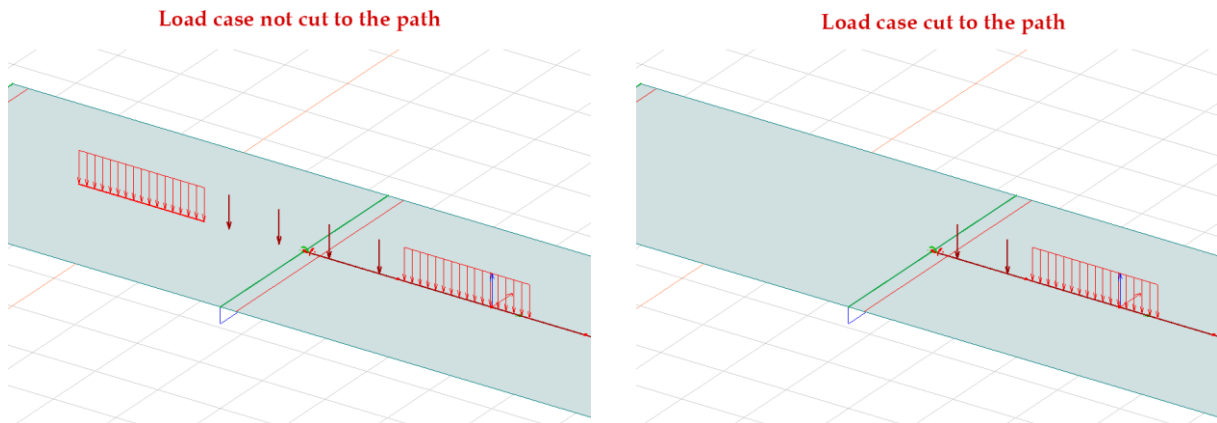

Originally vertical load parallel with the global Z axis

- 
 Cut load to path extent: if checked, every load case of the Moving load gets analysed. If it extends over the path, then the software trims off the overhanging part.



User can select the set of loads to apply in the Vehicle tab.



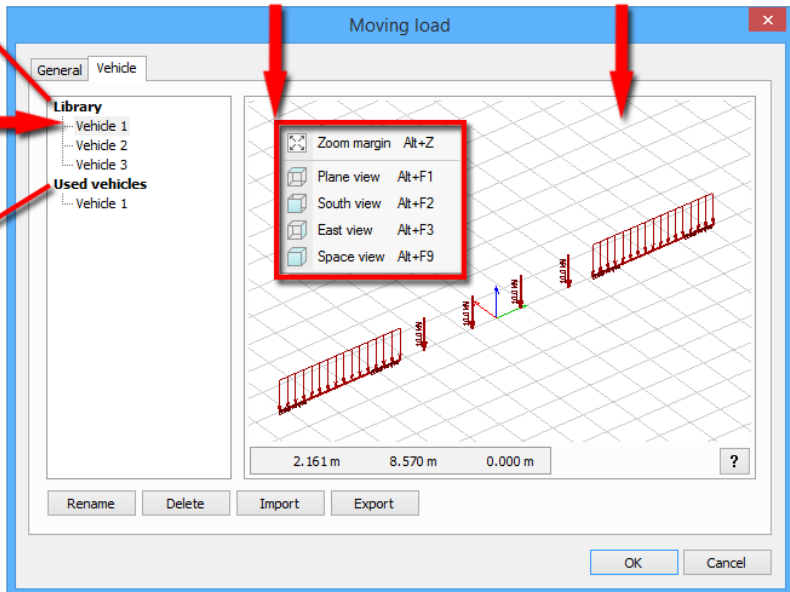

 : Animate pan
 +  : Orbit
 : Open View menu Scroll  : Animate zoom

 : Select Vehicle to use along the path

List of Vehicles defined in the Library
 List of Vehicles used in the model

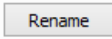

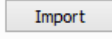
The functions of the buttons at the bottom of the dialog:

-  : Rename selected Vehicle
-  : Delete selected Vehicle
-  : Import Vehicle library from existing (*.vehicle) file
-  : Export Vehicle library to file

2.2.2 Defining Vehicles

The steps of Vehicle definition:

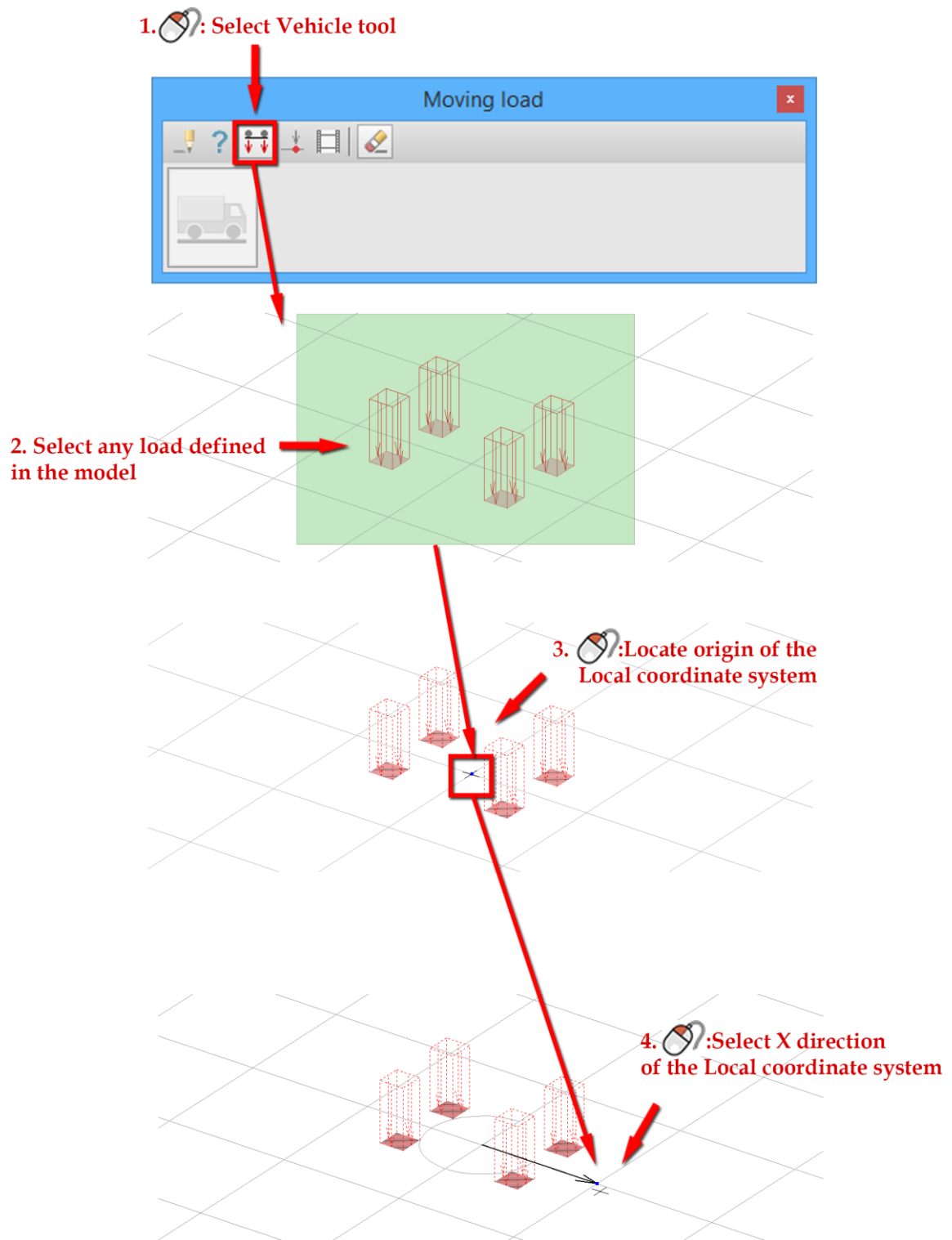

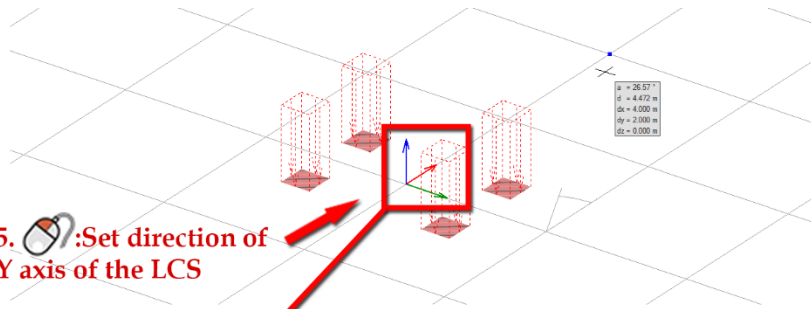

5. : Set direction of Y axis of the LCS

6. Type the name of the Vehicle

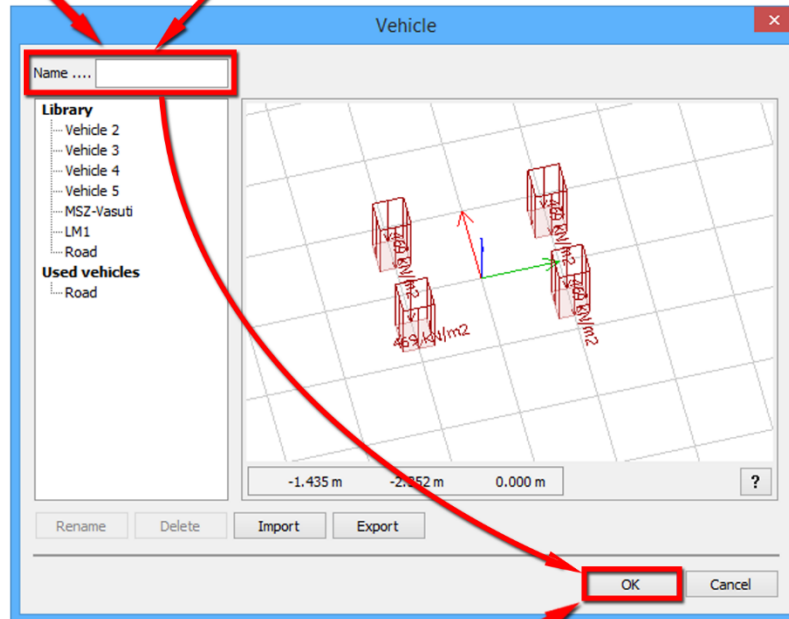

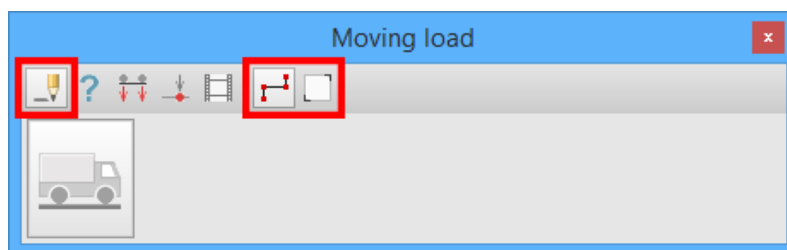

7. : Finish definition

2.2.3 Summary of Moving load functions



Define: the regular Define tool. It has two options:

-  Draw path: selecting it allows User to define Path by its corner point.
-  Select path: when selected, path can be defined from existing linear objects, such as drawing lines, bars, edges of plates or walls.



Properties: the regular Properties tool.







Vehicle: User can define Vehicles with it. This tool has the option:

-  Delete original load: if activated, loads used for the definition of Vehicle will be deleted



Vehicle position: allows the modification of Vehicle positions.

-  Add: defines a Vehicle position in a selected point along the path
-  Delete: removes the selected Vehicle position
-  Move: changes the position of the selected Vehicle position along the path
-  Reset: redefines all Vehicle positions on the selected path according to the Preferences of the Moving load. It removes all former modification of Vehicle positions.



Animate motion: Plays an animation that shows each load case of the Moving load, one after the other. The speed of the animation can be set with the slider.

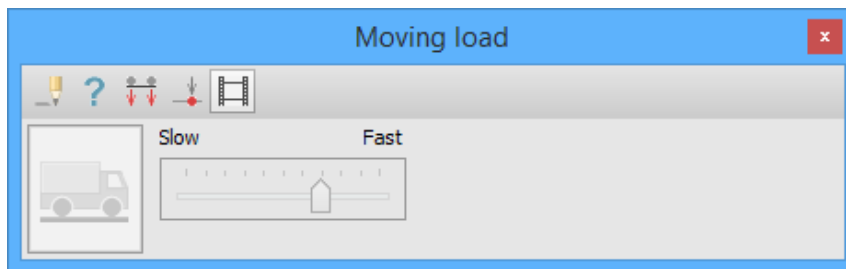

2.3. Seismic load, NA: Norwegian defaults

When running FEM-Design 15 with Norwegian configuration, the default values of Seismic load/Horizontal spectra tab are set according to the Norwegian National Annexes to Eurocode. Furthermore, the type of the horizontal spectra is locked to type 1.

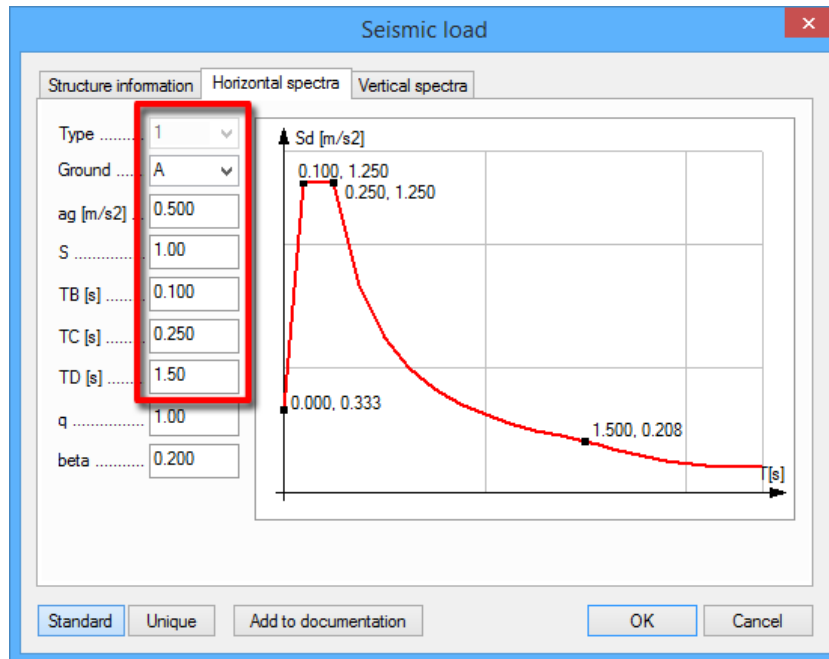

2.4. Optional simultaneous plus and minus directed wind loads

FEM-Design 15 allows User to define plus and minus directed wind loads for regular buildings at the same time.

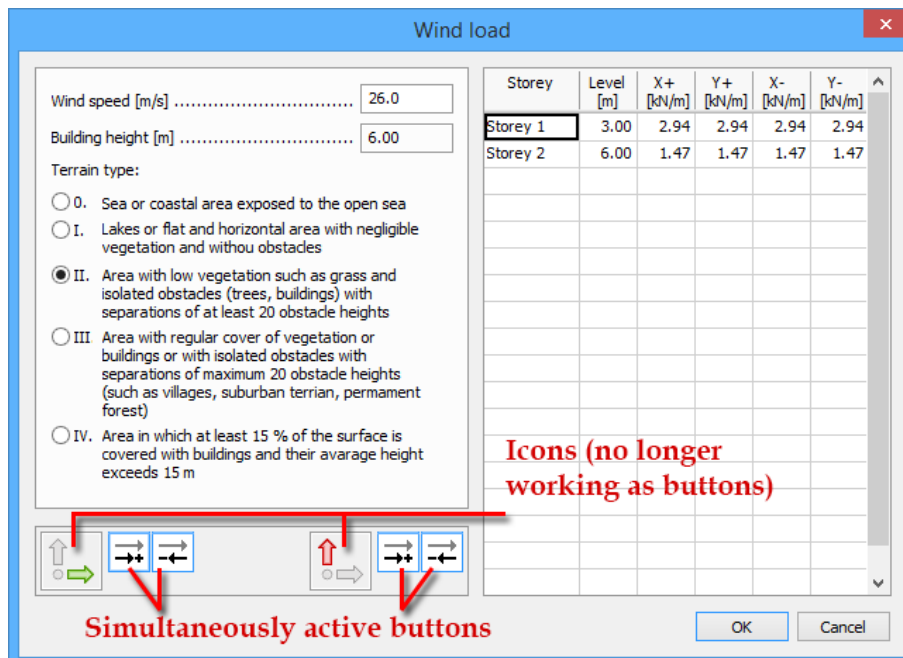

 While creating Wind loads FEM-Design 15 re-defines all existing Wind loads! That may delete previously defined Wind Load cases.

2.5. Automatic deviation load generation option

For the faster and more comfortable load definition X and Y directed deviation loads can be generated simultaneously. Furthermore, with the new "Generate All" button it is possible to set up the deviation loads of the chosen directions for all storeys.

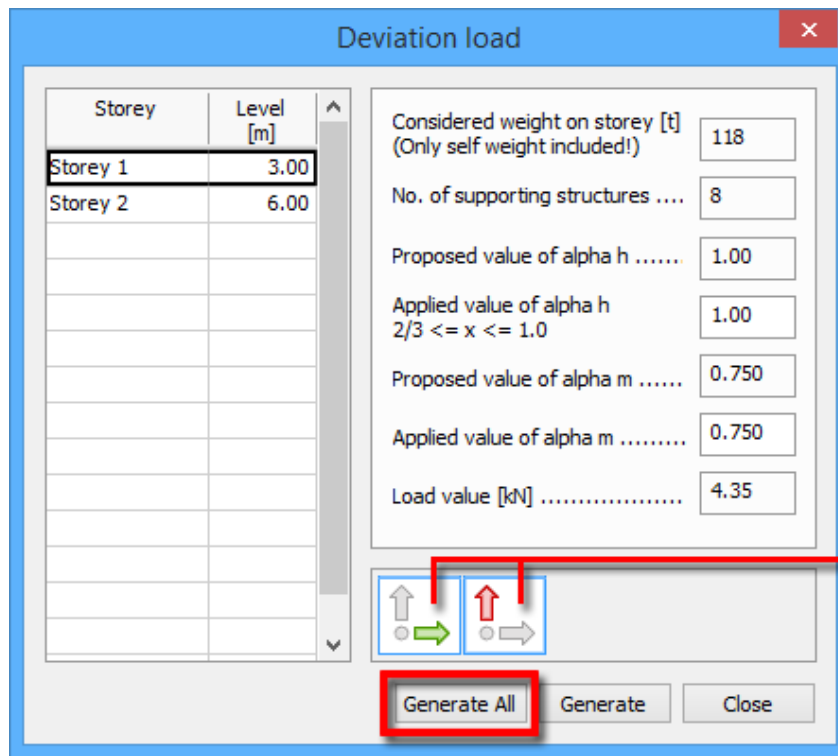

Buttons can be active at the same time



Generate All button re-defines all existing Deviation load with the default properties. That may delete previously defined Deviation Load cases

2.6. Unlimited number of load cases, groups and combinations

There are no longer any limits for numbers of load cases, load groups and load combinations.

3. FINITE ELEMENT MESH

3.1. Real 3D soil finite elements

If “Calculate soil as solid element” is active, FD automatically generates 3D finite elements for the Soil object and compatible 2D and 1D mesh for the surface and line element.

FD 15 prefers to create cuboid elements (cubes, if possible), but there are some geometrical cases where it uses triangular/quadrangular prism, tetrahedron and pyramid elements in order to build an optimal spatial mesh.

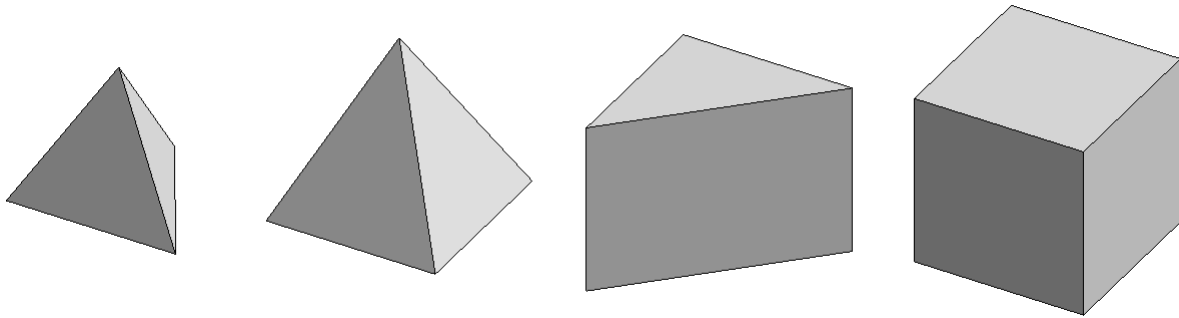

The 3D mesh can handle generic solids with geometrical situations considering boundary and inner geometry.

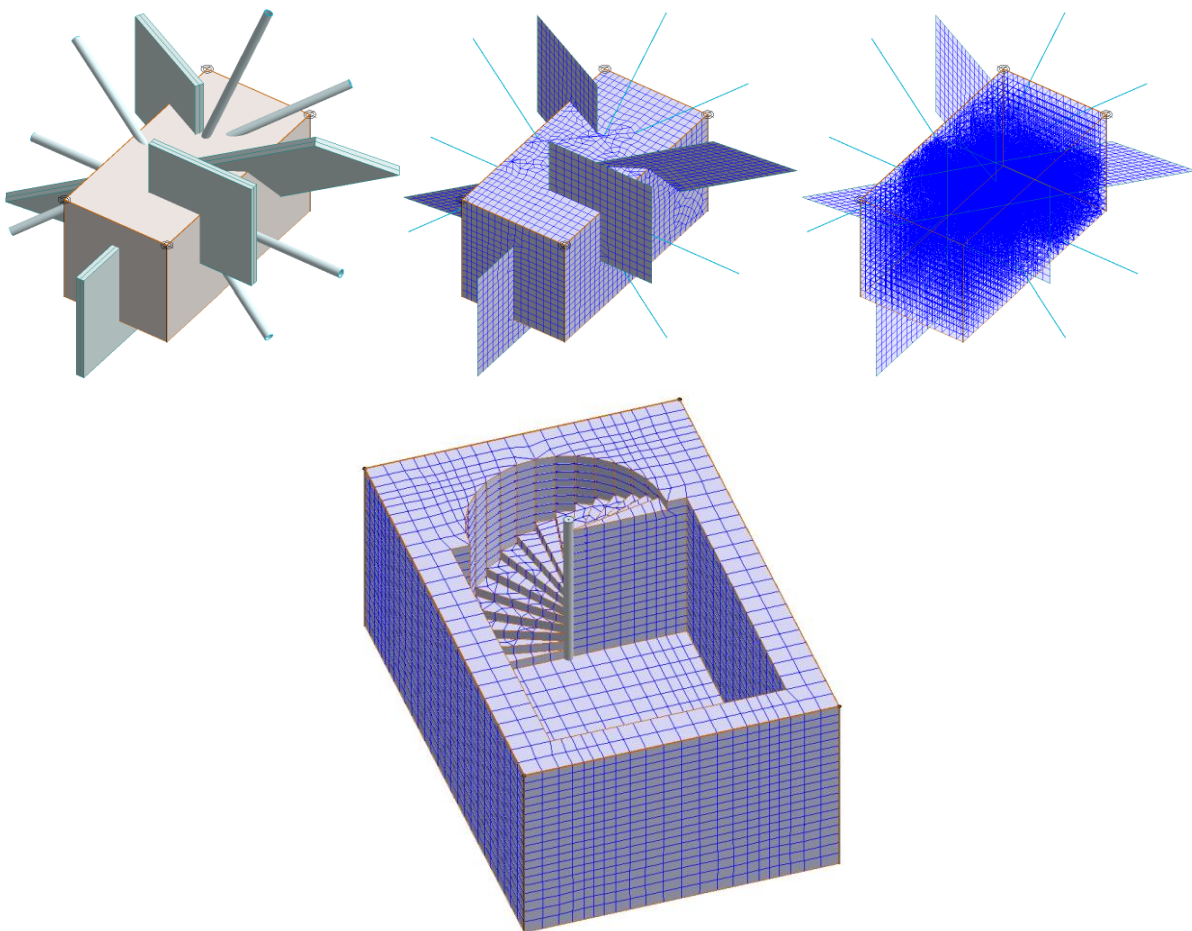

4. ANALYSIS

4.1. Modified Calculations and Setup load combinations dialogs

Calculation dialog has changed in all modules. When opening it and selecting Calculations/Analysis/Load combinations, User can see that the Non-linear settings are moved into the Calculation options dialog

FEM-Design 14

FEM-Design 15

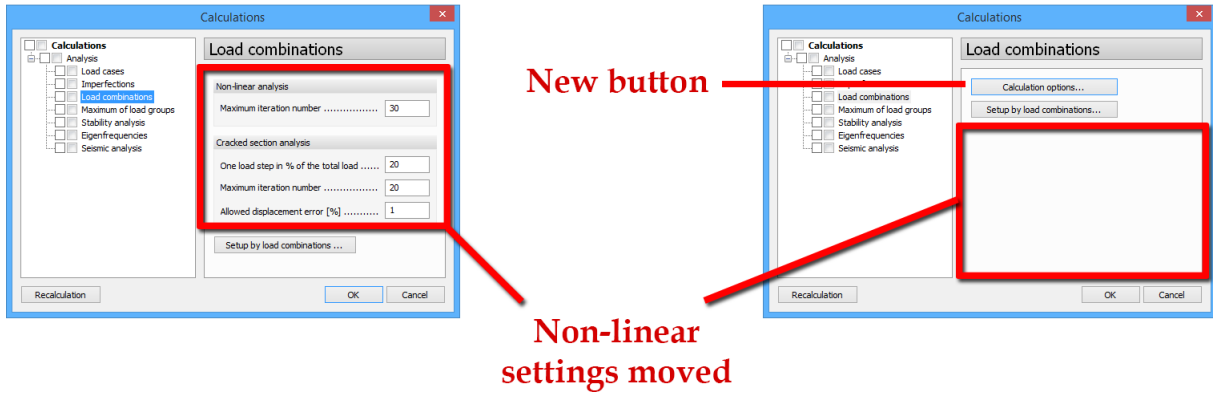

In the Calculation options dialog the preferences of the following analysis methods can be set:

- Non-linear analysis
- Non-linear soil (more in paragraph 1.1 and 4.2)
- Cracked section analysis

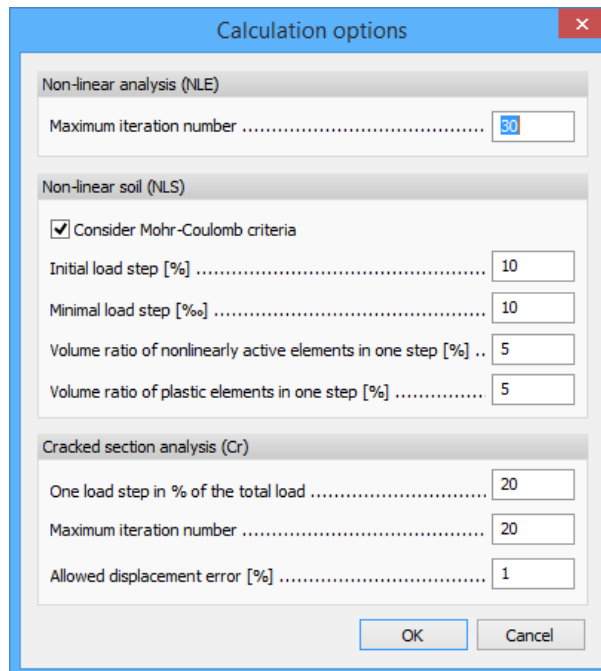

The Setup by load combinations dialog contains two new columns described in paragraph 4.2 and 4.3.

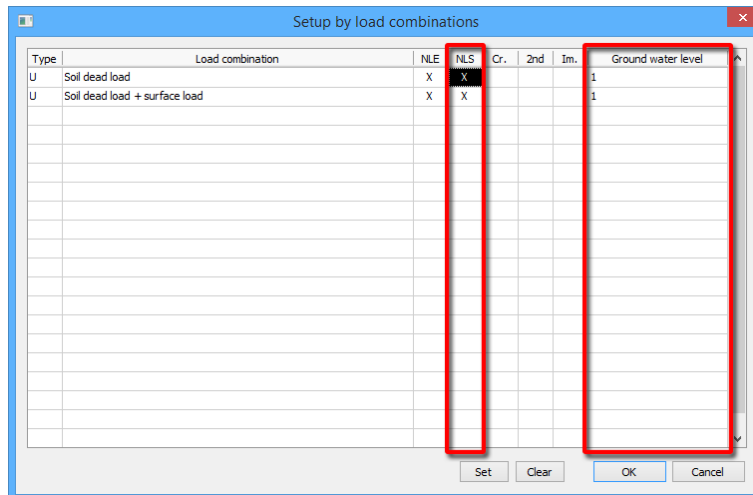

4.2. Non-linear soil calculations

With the new types of Soil material and the option of considering soil as solid element, User can run Non-linear soil (NLS) calculations. It requires the followings:

- specifying the NLS preferences (iterative procedure parameters) in the *Analysis/Calculations/Load combinations/Calculation options* dialog
 - If the “Consider Mohr-Coulomb criteria” is enabled the soil plasticity is considered in the calculation

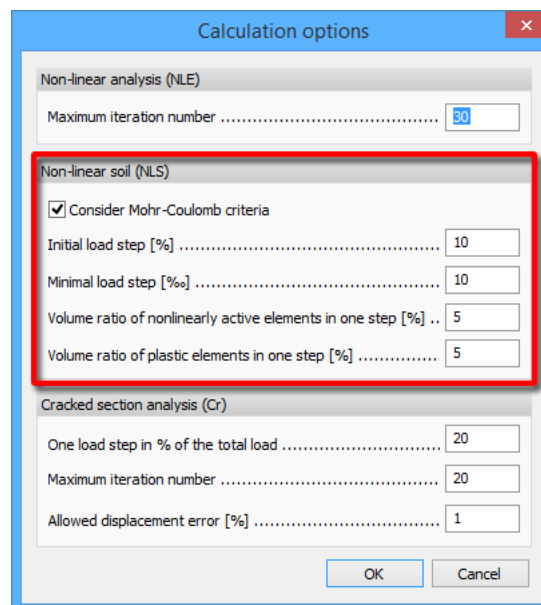

For theoretical information about the Non-linear soil calculation see in [3D Soil theory manual](#)

- in the *Analysis/Calculations/Load combinations/Setup by load combinations* dialog deciding that in which combinations non-linearity should be considered.

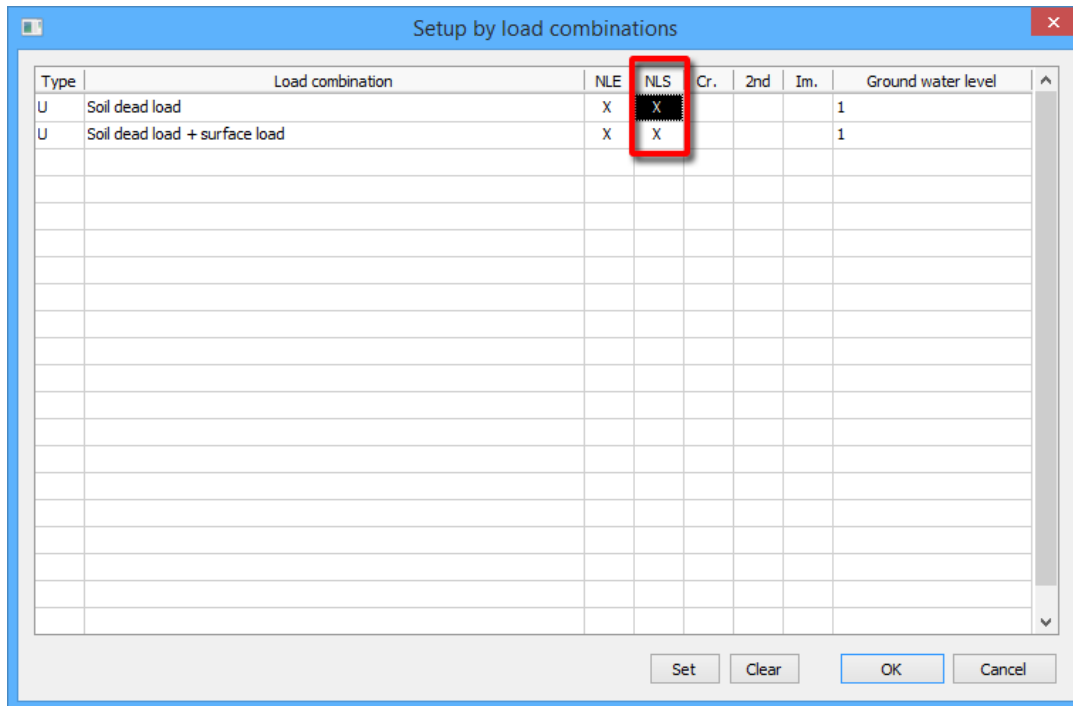

The analysis with non-linear soil takes two steps. In Phase 1 the calculations will be processed only with the dead load of the Soil object (if that particular Load case is available). In Phase 2 all the other Load cases will be considered.

4.3. Varying Ground water level by Load combinations

In FEM-Design 15 User can decide which Ground water level (GWL) the program shall use for each Load combinations during the calculation process.

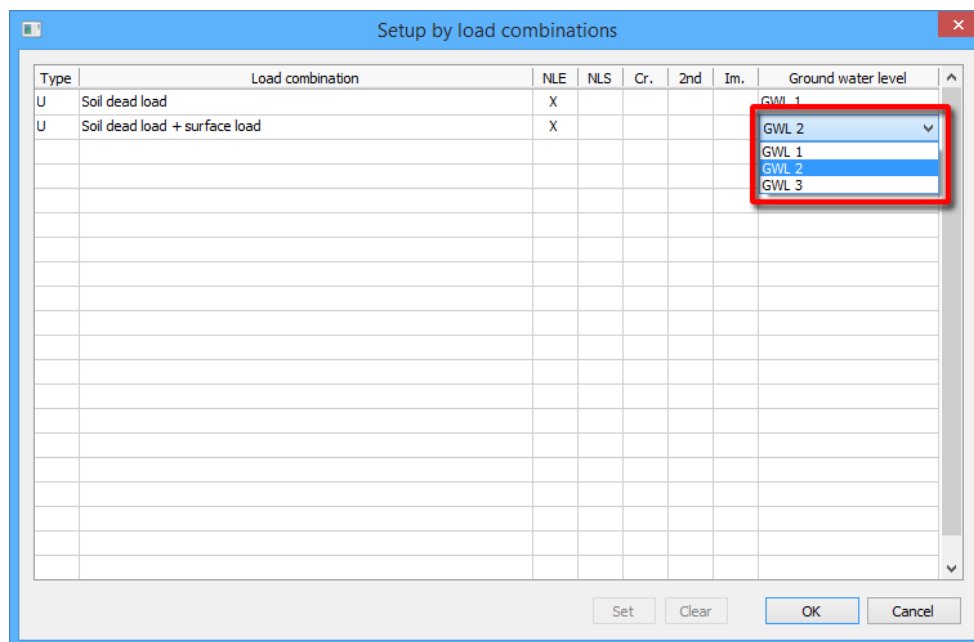

4.4. New calculation result: Large volumetric strain

With the new 3D finite elements of soil, calculations may end with the “Large volumetric strain was found” message.

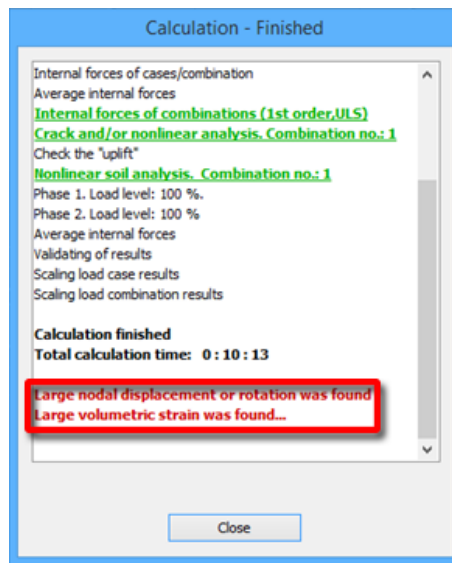

5. RC DESIGN

5.1. Shear capacity

The previous versions of FEM-Design use the method described in EC 2 1-1: 6.4 for calculating shear capacity of RC shells. FD 15 uses the procedure specified in EC 2 1-1: 6.2.4.

5.2. User-defined $\cot(\Theta)$

In FEM-Design 15 User can change the value of $\cot(\Theta)$ for each RC bar. This variable has importance at the bar reinforcement design (more details in EC 2).

It can be set in RC design/Design calculation parameters dialog, in a range between 1.00 and 2.50.

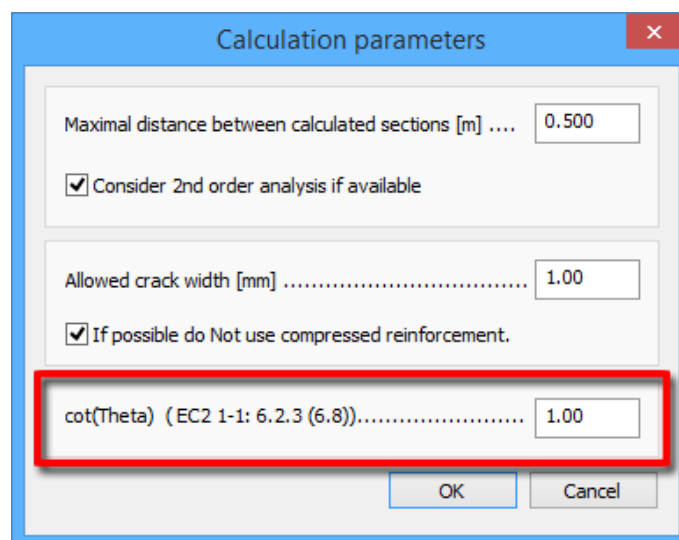

5.3. Regular Isolated foundation

Reinforcement slab design is carried out for Regular Isolated foundations in case of “Supported by soil” and “Surface support group” analytical system.

Without active “Calculate soil as solid element” option

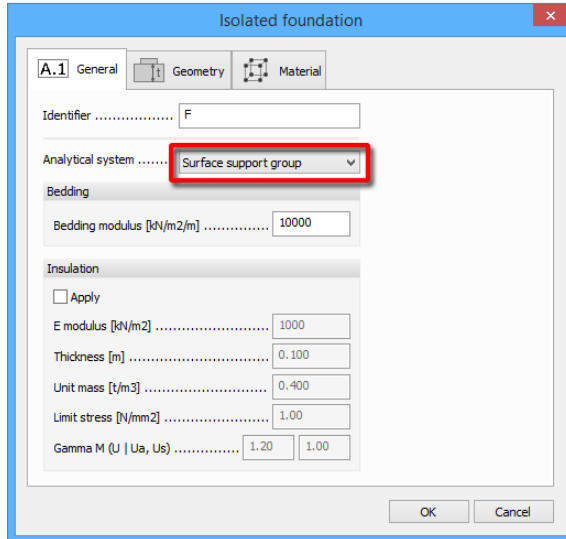

With active “Calculate soil as solid element” option

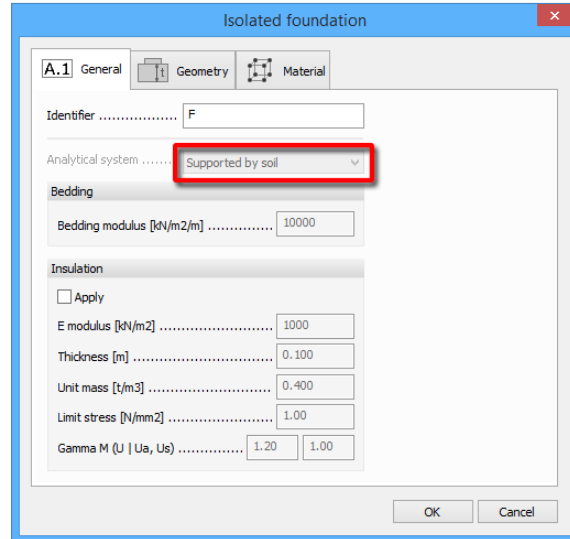

User can apply Surface reinforcements for Regular Isolated foundations in the same way as for Shells.

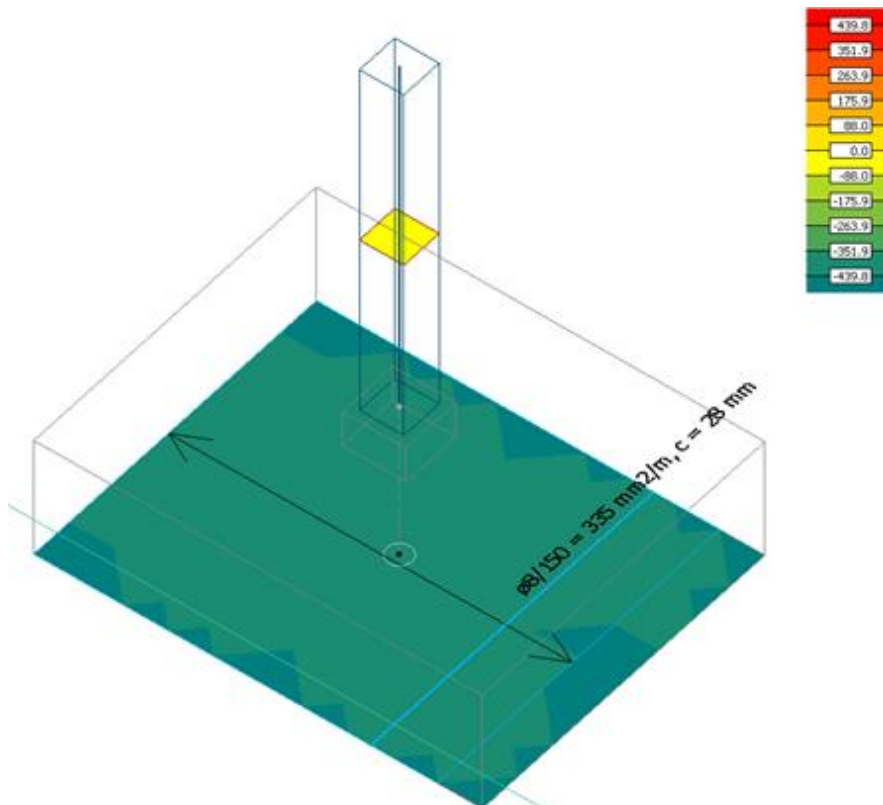

6. DISPLAY RESULT

6.1. Moving load results

6.1.1 Moving load maximum

The new type of results, Moving load maximum, is similar to Maximum of load combinations. It shows the maximum values of the selected result in all points of the model, under the effects of a Moving Load. User can change the Load combination and the Moving load of which results he or she wants to display.

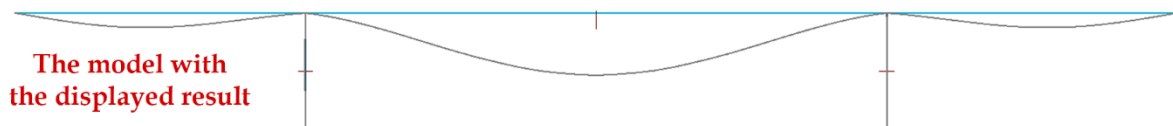
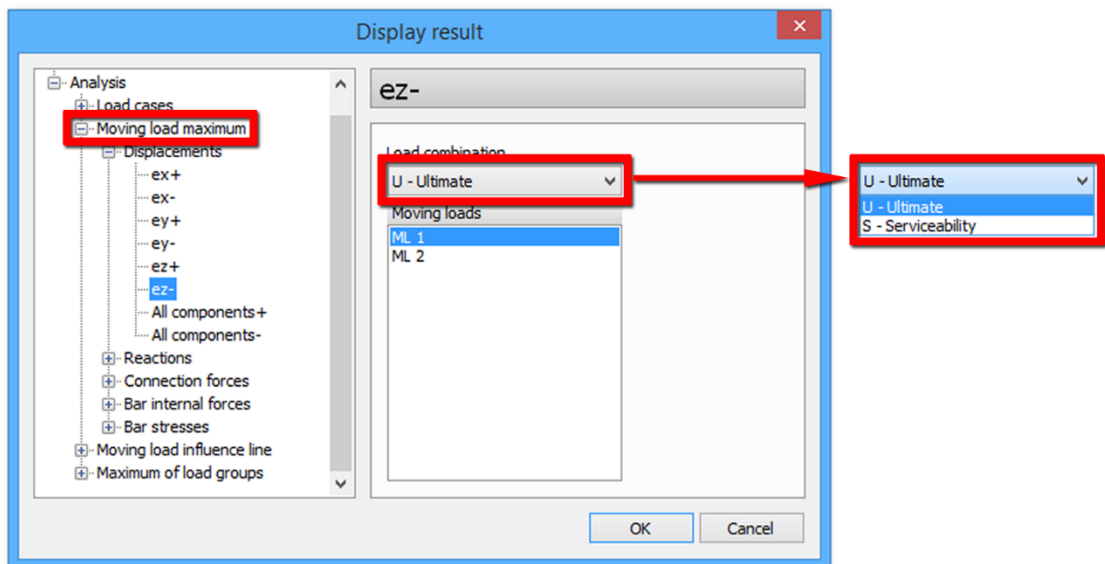
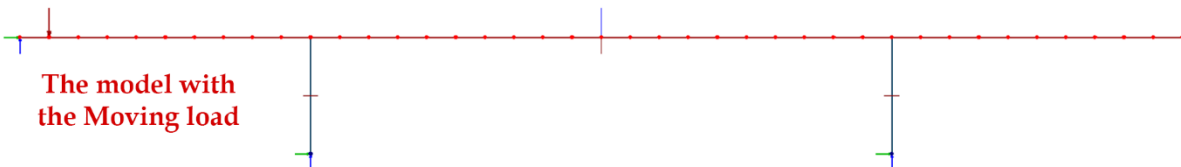

6.1.2 Moving load influence line

The Moving load influence line shows how the value of the selected result changes in a user-defined point of an object, while the Vehicle moves along the path.

User can define it with the following steps:

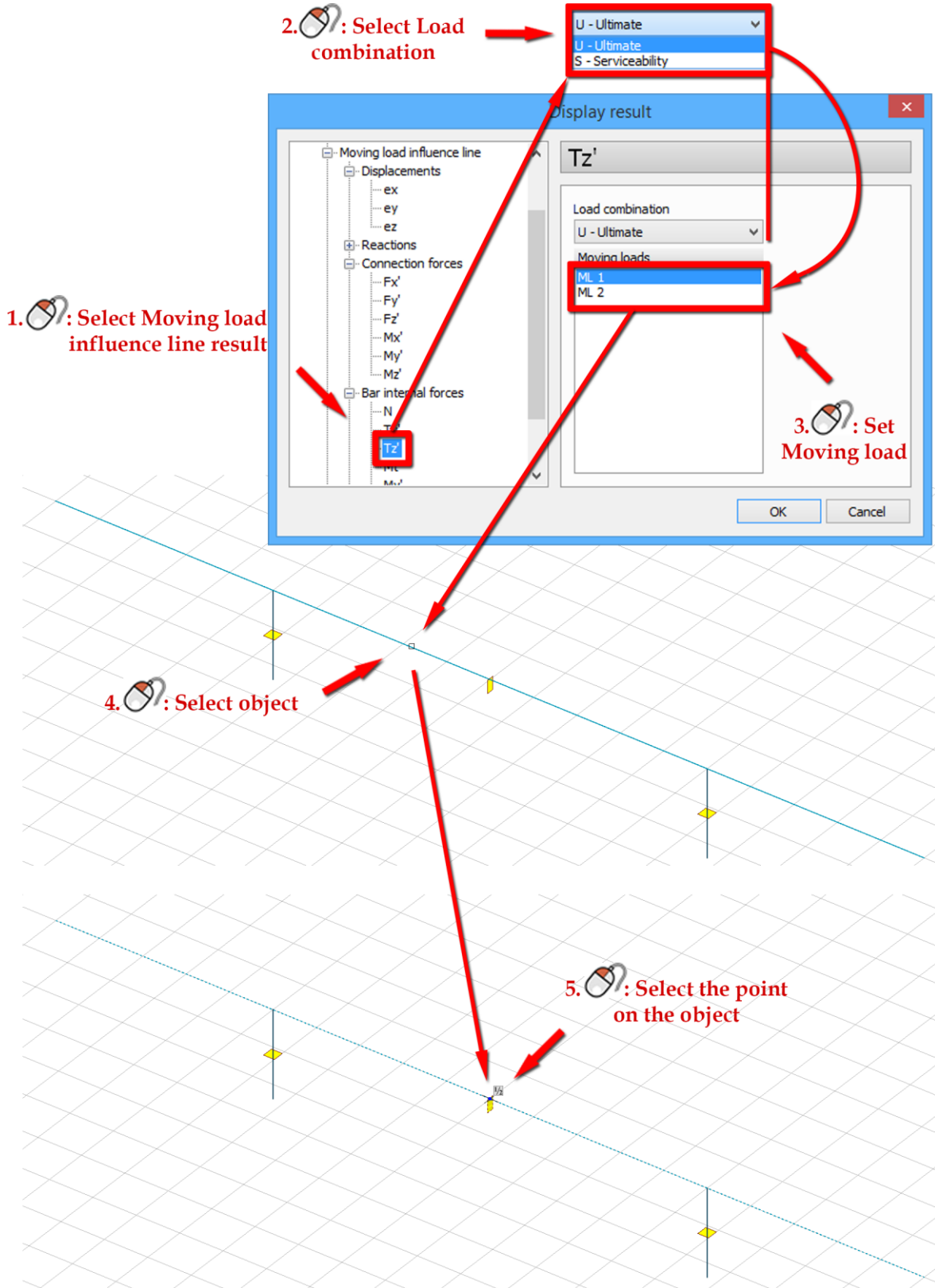

The results are displayed similarly to the one in the figure below:

**Vehicle positions marked
with red dot**

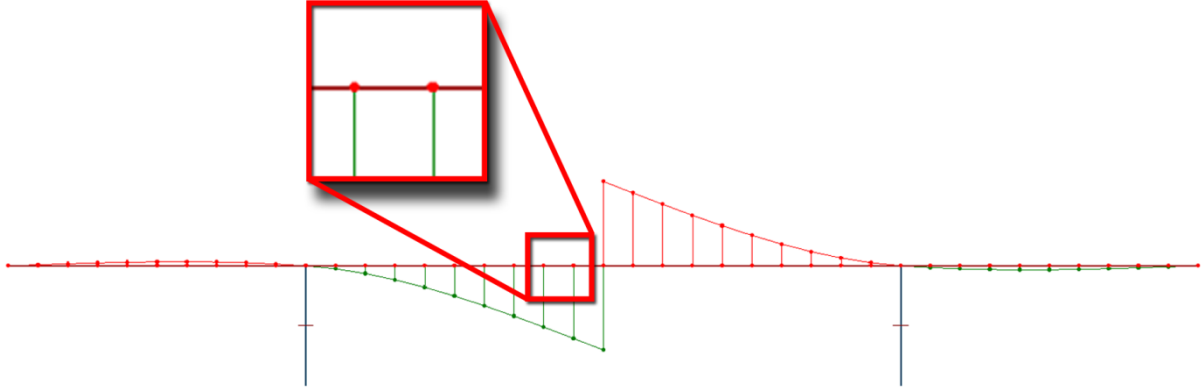

 Since Moving loads are based on singular load cases, these result values are exact only in the Vehicle positions. The other points of the curve show approximate values. Accuracy can be increased by defining more Vehicle positions, however, it increases calculation time, too.

6.1.3 Moving load's cases

Although Moving loads are based on singular load cases, they are managed differently than regular load cases. It is possible to create an animated result for a Moving load. The figure below shows the method:

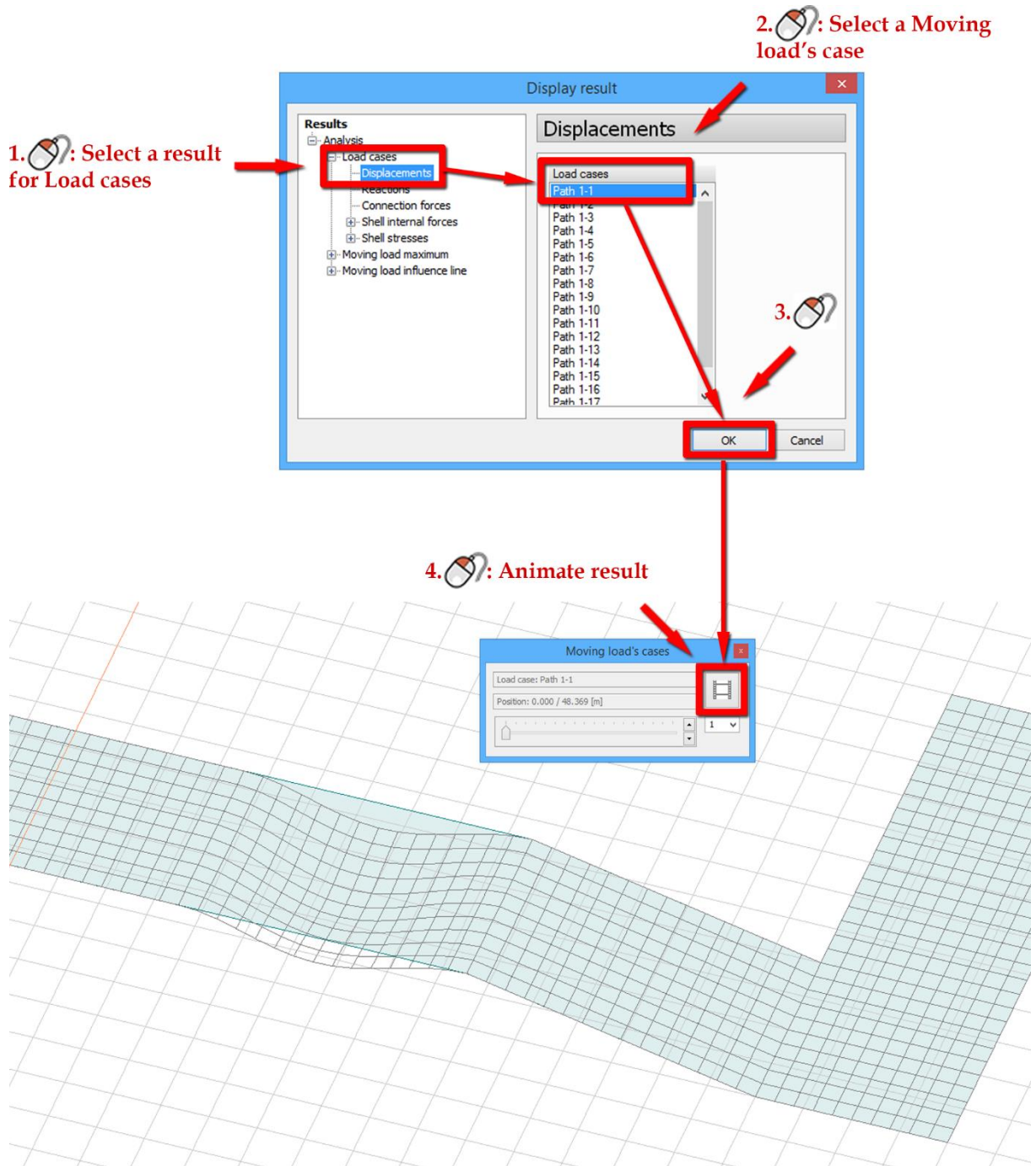

The animation displays the changing of the selected result while the Vehicle moves along the path.

The next figure describes the new Moving load's cases dialog:

: Switch among Moving load's cases with mouse scroll while the dialog is active

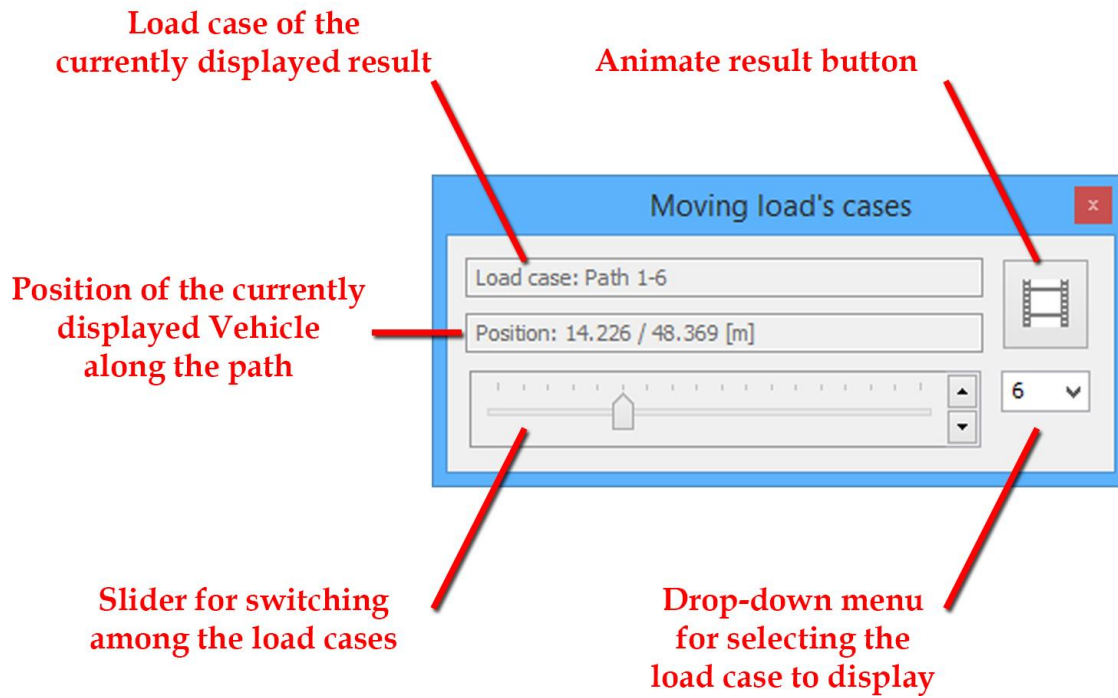

 Animate result button in the Moving load's cases dialog has a different effect than the regular Animate result button in the Analysis and the Design tabs.

6.2. Non-linear soil analysis

6.2.1 Soil plastic condition

User can display the “Soil plastic condition” result of non-linear soil calculations for each Load combination. This option displays the integration points, which are in plastic condition, with red dots.

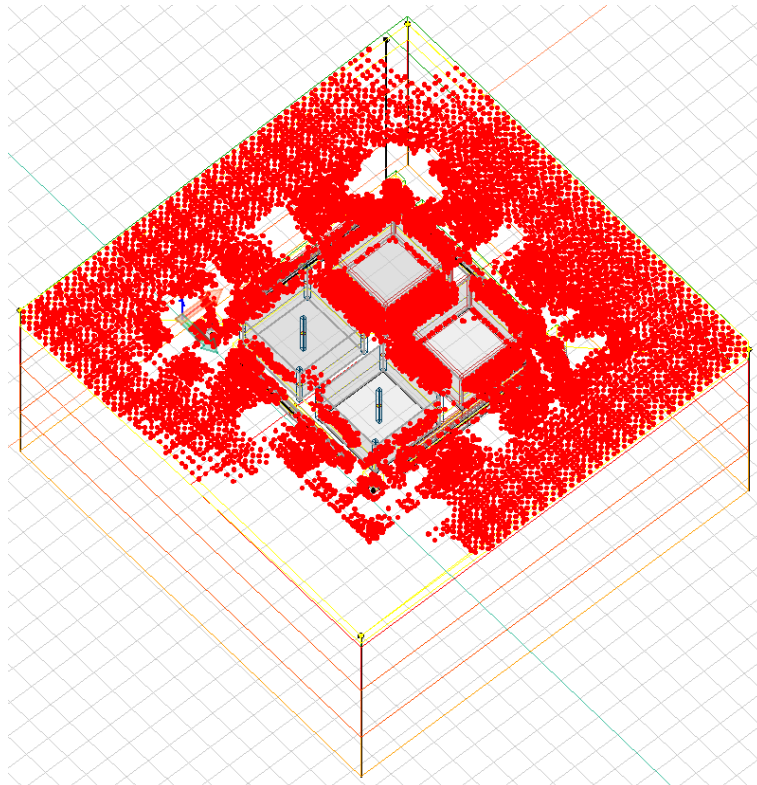
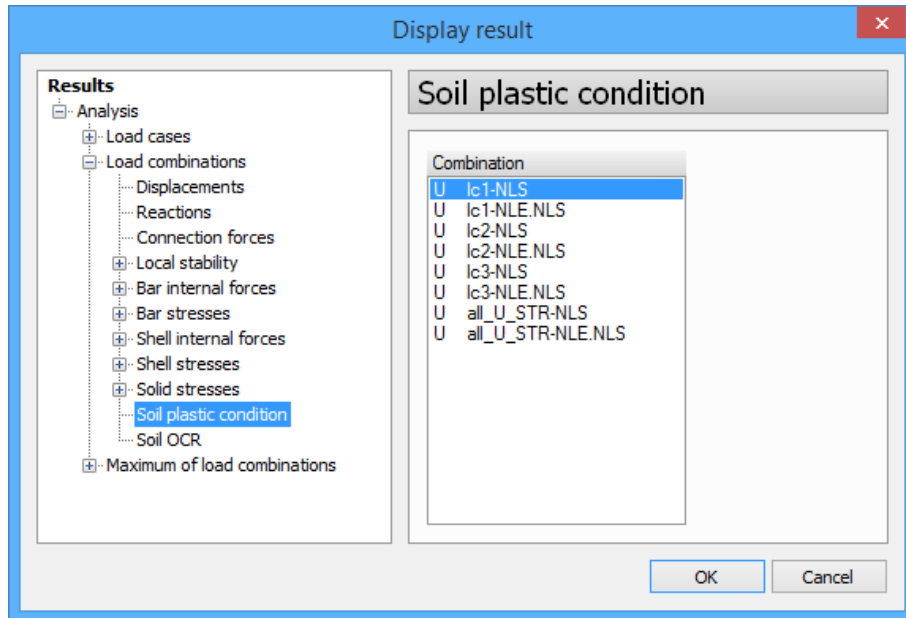

6.2.2 Over consolidation ratio

This result shows the Over consolidation ratio (OCR) for certain Load combinations in every integration point. The formula to determine the OCR in a certain point is:

$$OCR = \frac{p_c}{p_0}$$

where:

- p_c is the mean effective preconsolidation stress defined by the material model for overconsolidated soil
- p_0 is the mean effective stress calculated from the initial soil

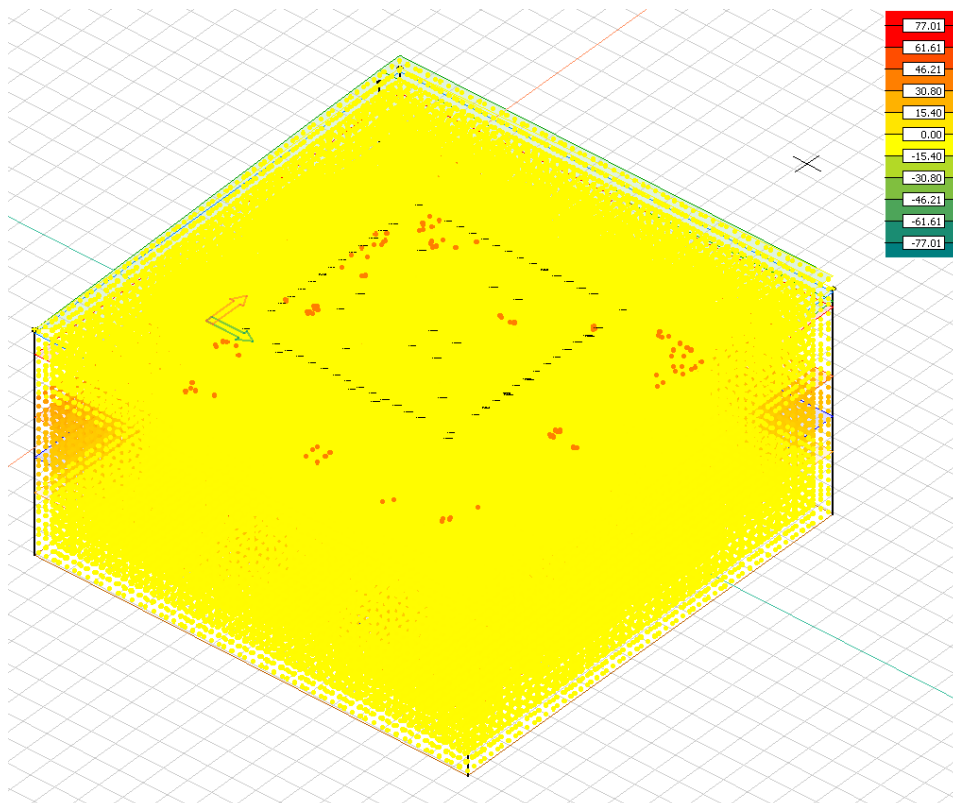
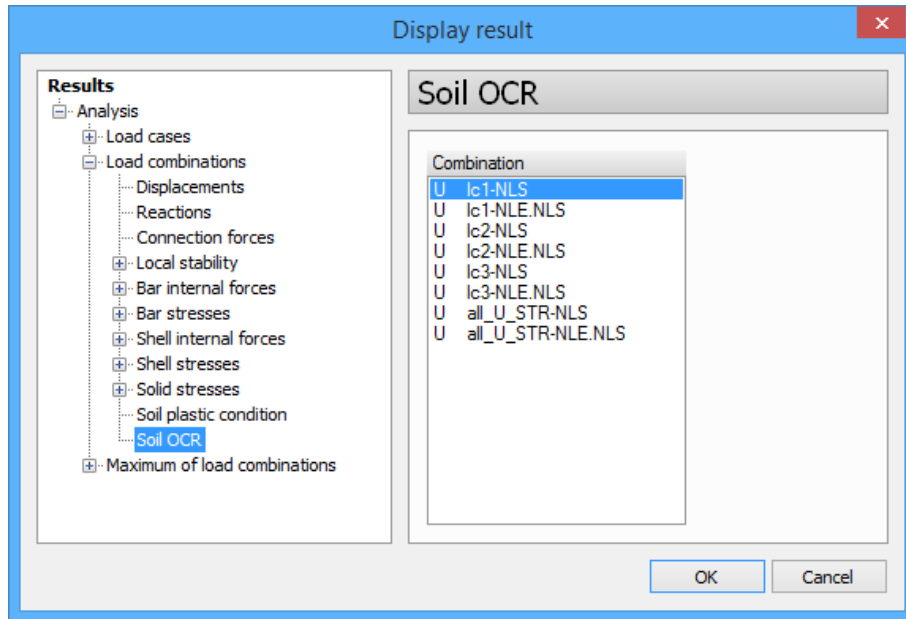

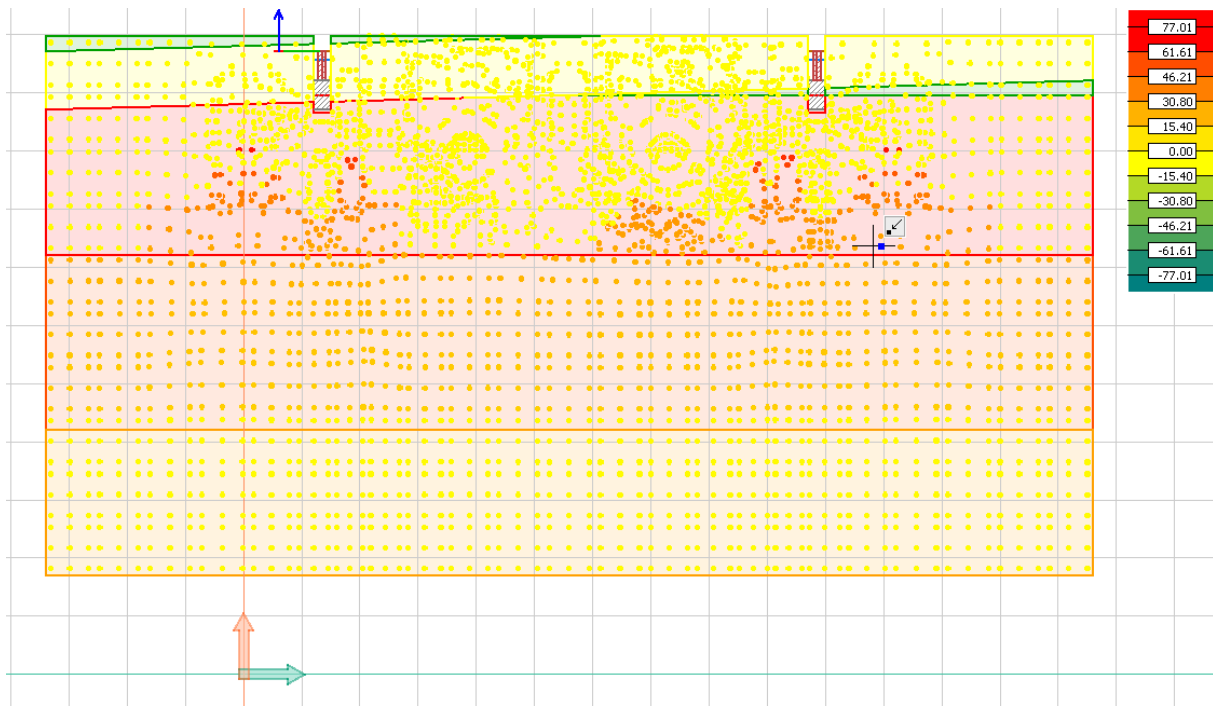

6.3. Seismic accelerations

As a new type of Displayed results, Acceleration of Seismic analysis can show the volume of acceleration in every grid point of the finite element mesh.

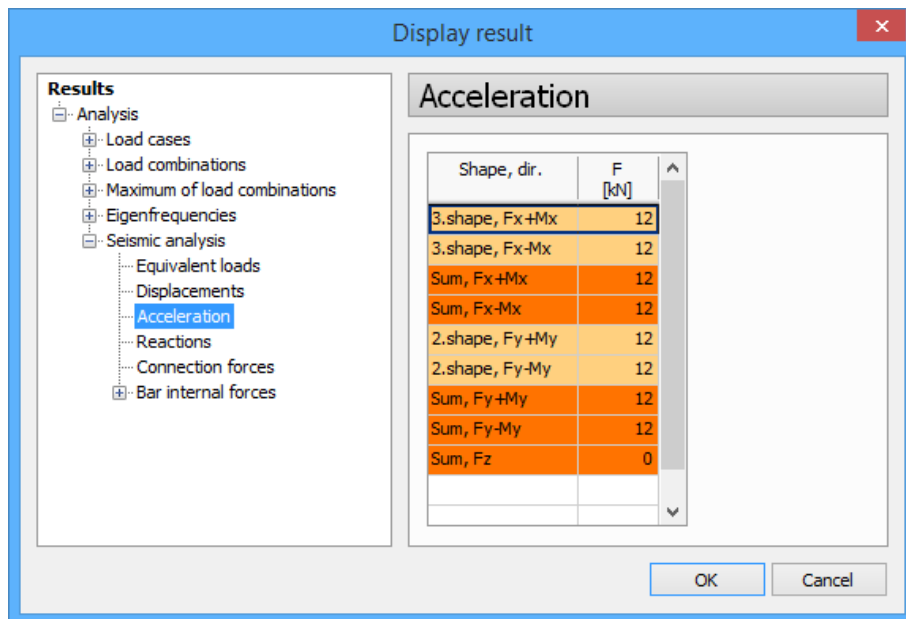

FD displays the result in the same way as the displacements but the unit different (m/s^2).

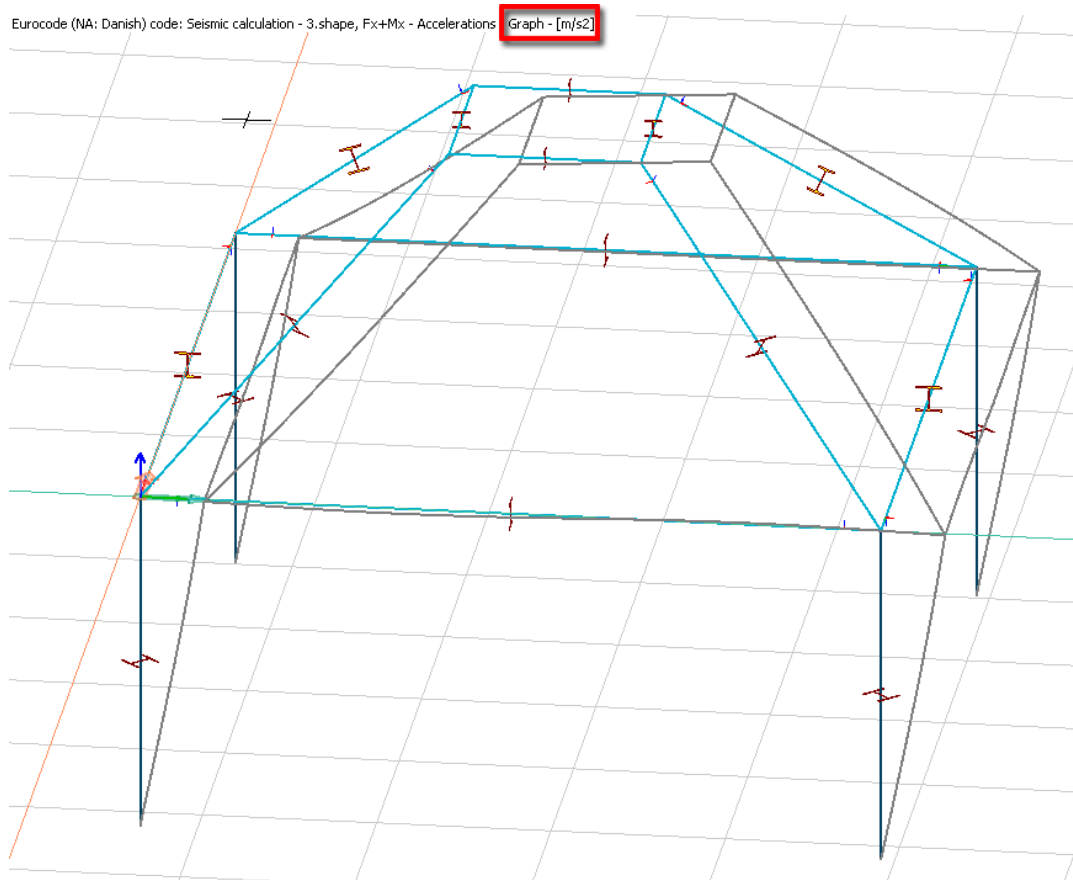

 Acceleration results are available only in case of Modal analysis.

6.4. Insulation results

In case of isolated and wall foundations the insulation utilization result is displayed in the *Foundation design/Check/Utilization dialog*, in the new "INS" column. The insulation check calculation is stress based, calculated by the acting force from the analysis (V_e) divided by the compression area (A).

Utilization				
Group	Total weight [t]	Max. [%]	Min. [%]	
F.1	54.0	166	166	

Item	Max. [%]	BE [%]	SL [%]	SE [%]	INS [%]
F.1	166	77	0	0	166

Buttons: Check, < Hide details

It also appears in the Detailed result.

Soil bearing utilization (Part 1:2.4.7.3, 6.5.2, Annex D)

LC: Load combination 1' (GEO 2)

Water level: -10.00 m

Undrained condition

$$V_d = V_{anal} + \gamma_G \cdot G_r + \gamma_G \cdot G_b = 17.68 + 1.00 \cdot 529.46 + 1.00 \cdot 0.00 = 547.13 \text{ kN}$$

$$H_d = \sqrt{H_{kx}^2 + H_{ky}^2} = \sqrt{0.46^2 + 0.25^2} = 0.53 \text{ kN}$$

$$e_B = |M_{y,d} / V_d| = |8.79 / 547.13| = 0.64 \text{ m}$$

$$e_L = |M_{x,d} / V_d| = |4.44 / 547.13| = 0.32 \text{ m}$$

$$B' = B - 2 \cdot e_B = 4.69 - 2 \cdot 0.64 = 3.41 \text{ m}$$

$$L' = L - 2 \cdot e_L = 4.51 - 2 \cdot 0.32 = 3.86 \text{ m}$$

$$A' = B' \cdot L' = 3.41 \cdot 3.86 = 13.15 \text{ m}^2$$

$$s_o = 1 + 0.2 \cdot \min(B' / L', L' / B) = 1 + 0.2 \cdot \min(3.41 / 3.86, 3.86 / 3.41) = 1.18$$

$$i_o = 0.5 \left\{ 1 + \sqrt{1 - \frac{\min(H_{Ed}, A' \cdot c_{uk} / \gamma_{ou})}{A' \cdot c_{uk} / \gamma_{ou}}} \right\} = 0.5 \left\{ 1 + \sqrt{1 - \frac{\min(0.53, 13.15 \cdot 130.00 / 1.40)}{13.15 \cdot 130.00 / 1.40}} \right\} = 1.00$$

$$q = (\sum_{ndry} [\gamma_k d_j] + \sum_{nsat} [\gamma'_k d_j]) \gamma_w = 0.00 \text{ kN/m}^2$$

$$R_d = [(\pi + 2) (c_{uk} / \gamma_{ou}) \cdot b_o \cdot s_o \cdot i_o + q] A' / \gamma_{k,v} =$$

$$= [(\pi + 2) (130.00 / 1.40) \cdot 1.00 \cdot 1.18 \cdot 1.00 + 0.00] 13.15 / 1.00 = 7386.03 \text{ kN} \quad (D.1)$$

$$V_d = 547.13 \text{ kN} \leq R_d = 7386.03 \text{ kN} \cdot \text{OK}$$

Soil sliding utilization (Part 1:2.4.7.3, 6.5.3, Annex D)

LC: Load combination 1' (GEO 2)

Water level: -10.00 m

Undrained condition

$$V_d = V_{anal} + \gamma_G \cdot G_r + \gamma_G \cdot G_b = 17.68 + 1.00 \cdot 529.46 + 1.00 \cdot 0.00 = 547.13 \text{ kN}$$

$$H_d = \sqrt{H_{kx}^2 + H_{ky}^2} = \sqrt{0.46^2 + 0.25^2} = 0.53 \text{ kN}$$

$$e_B = |M_{y,d} / V_d| = |8.79 / 547.13| = 0.64 \text{ m}$$

$$e_L = |M_{x,d} / V_d| = |4.44 / 547.13| = 0.32 \text{ m}$$

$$B' = B - 2 \cdot e_B = 4.69 - 2 \cdot 0.64 = 3.41 \text{ m}$$

$$L' = L - 2 \cdot e_L = 4.51 - 2 \cdot 0.32 = 3.86 \text{ m}$$

$$A' = B' \cdot L' = 3.41 \cdot 3.86 = 13.15 \text{ m}^2$$

$$R_d = \min(A' \cdot c_u / \gamma_{k,h}, 0.4 \cdot V_d) = \min(13.15 \cdot 92.86 / 1.00, 0.4 \cdot 547.13) = 218.85 \text{ kN}$$

$$H_d = 0.53 \text{ kN} \leq R_d = 218.85 \text{ kN} \cdot \text{OK}$$

Insulation utilization

LC: Load combination 1' (GEO 2)

$$\sigma_{Ed} = \frac{V_d}{A_c} = \frac{547.13}{13.15} = 41.60 \text{ kN/m}^2$$

$$\sigma_{Ed} = 41.60 \text{ kN/m}^2 > \sigma_{Rd} = \frac{\sigma_{Rk}}{\gamma_{M1}} = \frac{25.00}{1.00} = 25.00 \text{ kN/m}^2 \cdot \text{Not OK}$$

Summary

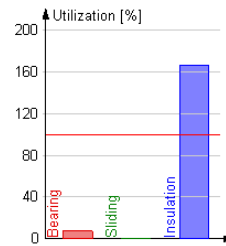

User can display the analysis results for Insulations of Foundation slabs in the *Foundation design/Display result* dialog.

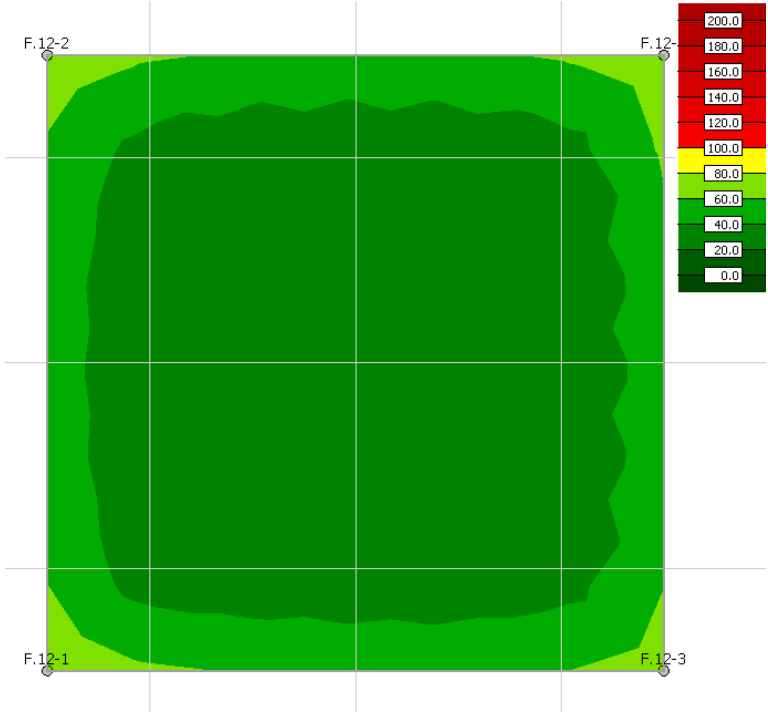
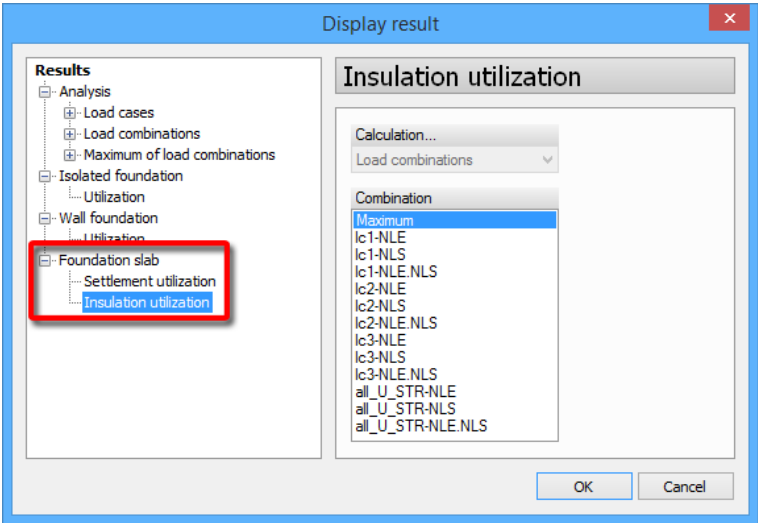

 Insulation results are calculated only for ULS combinations!

7. DOCUMENTATION

7.1. Export to .docx format

In order to make documentation more convenient for the User, in FD 15 it is possible to export the Documentation and any Detailed result to Office OpenXML (.docx) file.

In the Documentation module this feature can be accessed by the new “Save as .docx” button at the bottom right corner of the Navigation panel.

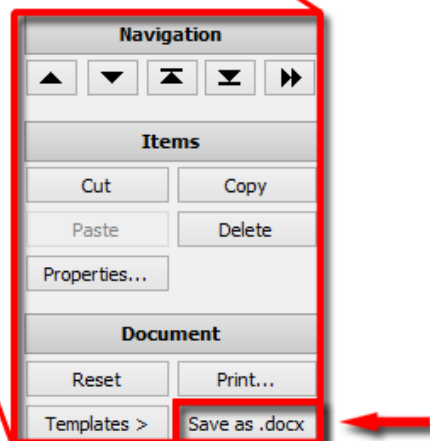
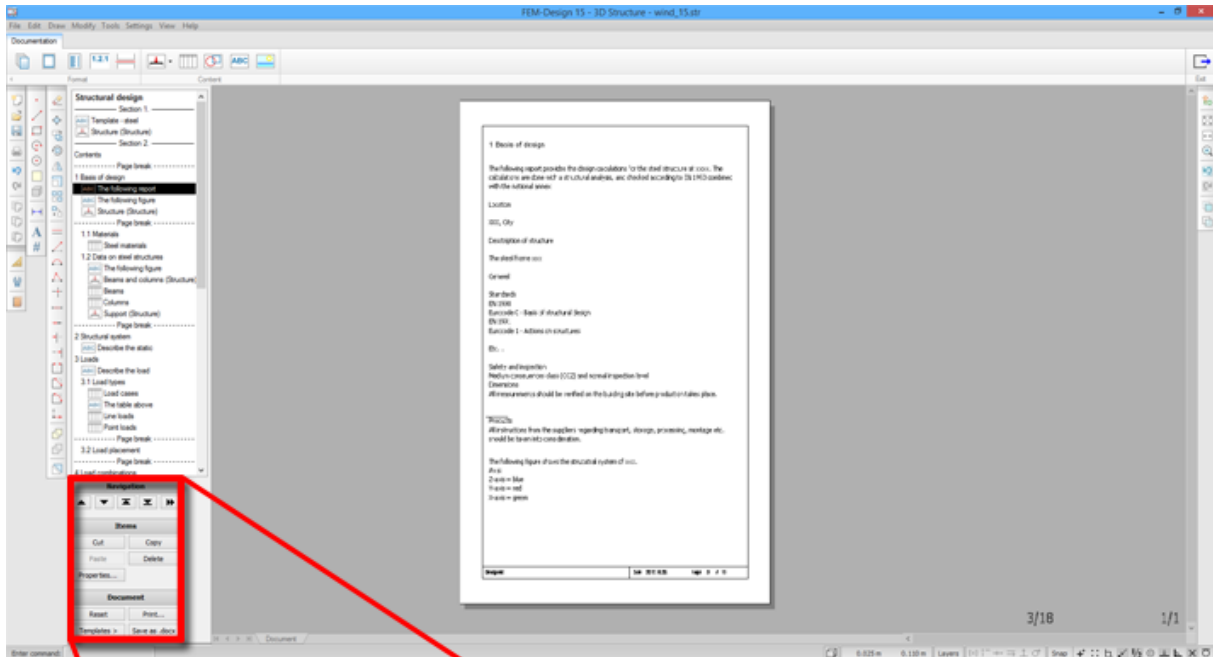

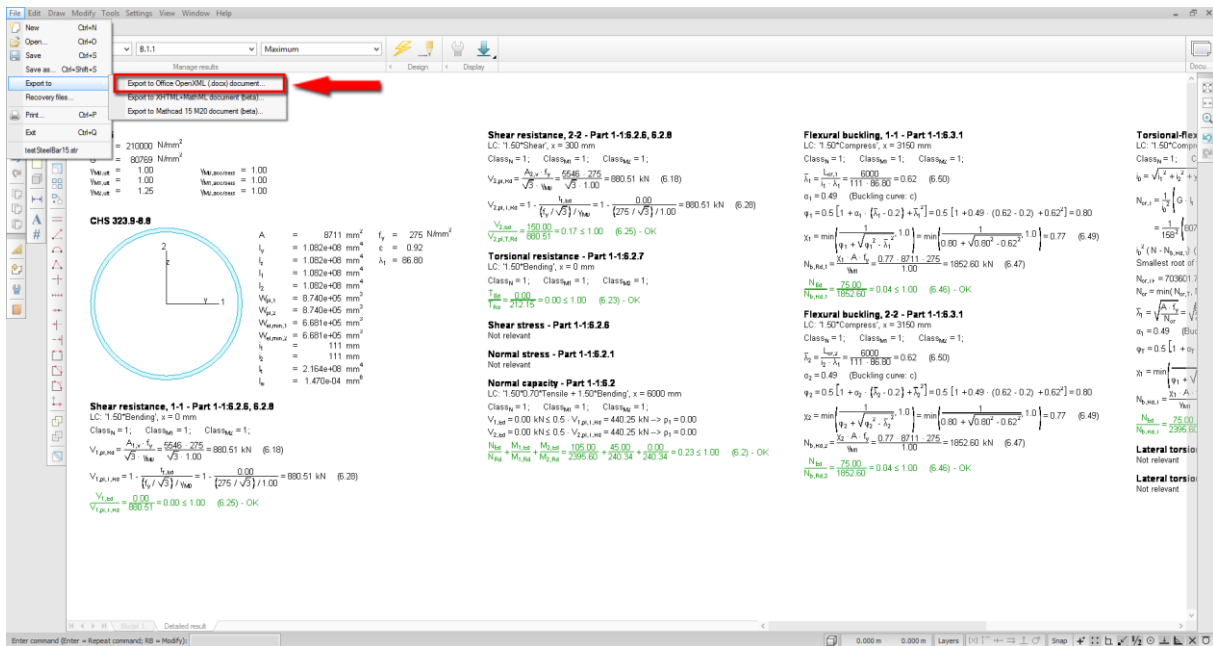

To export data from the Detailed result window use the File/Export to/Export to Office OpenXML (.docx) document command or directly the File/Export to Office OpenXML (.docx) document command where it is available.

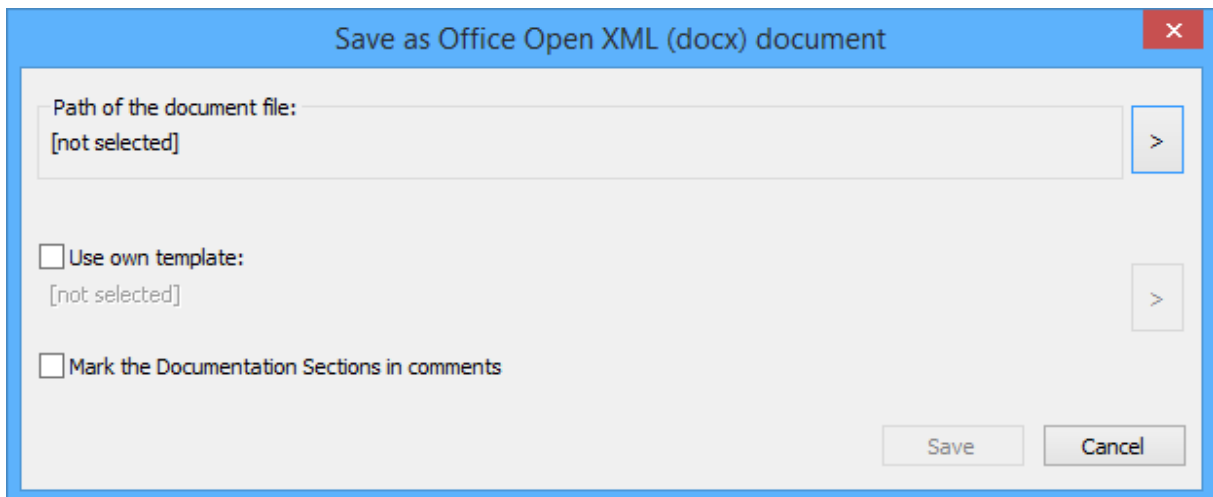

In both cases the “Save as Office open XML (docx) document” dialog appears, where User can decide the followings:

- where to save the result file
- which MS Office Word template file to use for the convention (optional)
- whether to mark the Documentation Sections in comments or not (only in Documentation module)



 MS Office Word 2007 or newer is required for opening files with .docx distribution

It is highly recommended to mark the documentation sections in the exported file, since the page rendering in MS Word and in FEM-Design are different. Furthermore, the exported document has A4 format pages. Therefore, if there are pages in the FD Documentation with different size, it is easier to find them and change their size in the result .docx file with section marks.

Using own Word templates is useful when the FD Documentation contains Title block, since it is not possible to export it to .docx. As an alternative, User can create a Word template with custom headers and footers, and use it for the exportation.

 Since MS Word has more sophisticated solutions for creating the table of contents, FEM-Design 15 does not export it to the .docx document. However, chapters are exported, therefore table of contents can be created in MS Word easily.

An example of the exported Detailed result can be seen in the following figure:

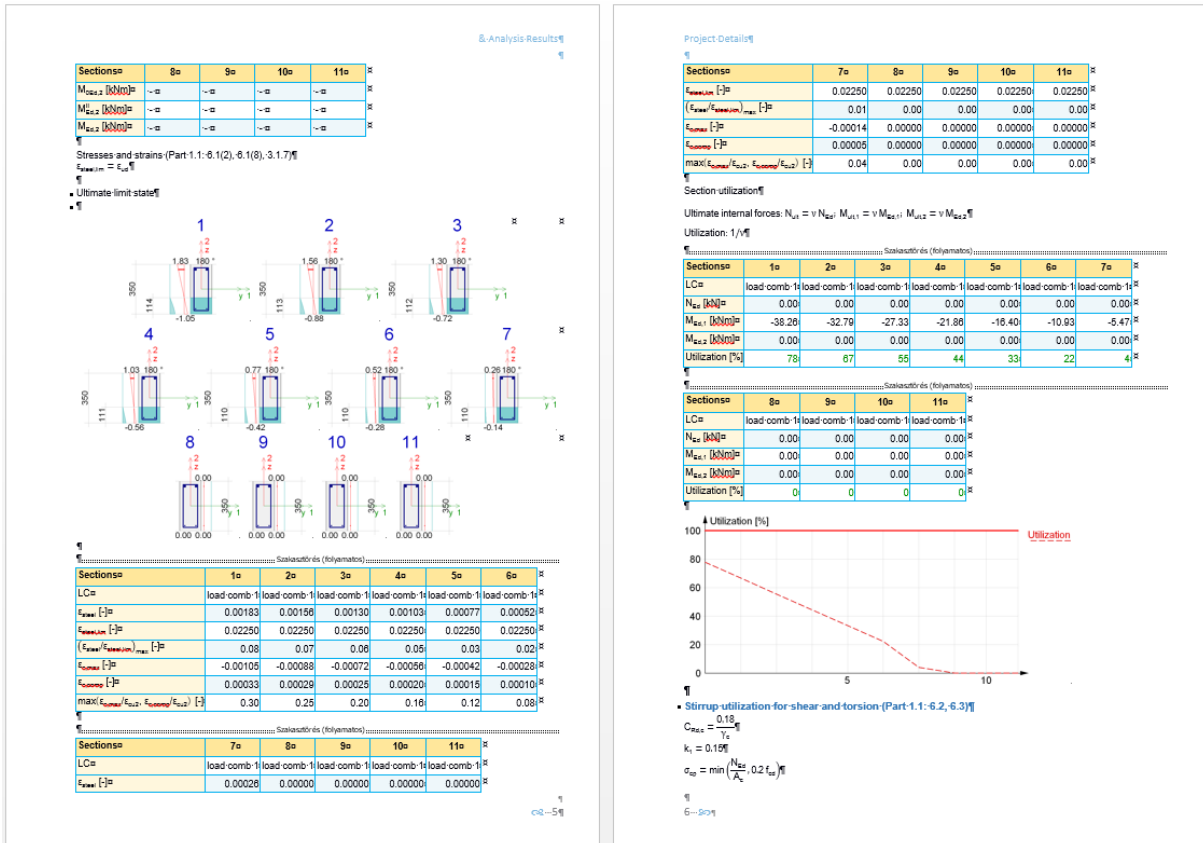

7.2. Export to Mathcad and to XHTML

User can export Detailed results to .xmcd (Mathcad 15) and to .html (XHTML with MathML). This opportunities can be accessed in the Detailed Result window's File/Export to menu. The .html exportation is available for the detailed results of all Designs, while the .xmcd is for Steel and Timber design.

The screenshot shows the 'Export to' menu with the following options:

- Export to Office OpenXML (.docx) document
- Export to XHTML+MathML document (beta)...
- Export to Mathcad 15 M20 document (beta)...

The main window displays technical data for a circular cross-section:

A	=	8711 mm ²	f_y	=	275 N/mm ²
I_y	=	1.082e+08 mm ⁴	ϵ	=	0.92
I_z	=	1.082e+08 mm ⁴	λ_1	=	86.80
I_1	=	1.082e+08 mm ⁴			
I_2	=	1.082e+08 mm ⁴			
$W_{pl,1}$	=	8.740e+05 mm ³			
$W_{pl,2}$	=	8.740e+05 mm ³			
$W_{el,min,1}$	=	6.681e+05 mm ³			
$W_{el,min,2}$	=	6.681e+05 mm ³			
i_1	=	111 mm			
i_2	=	111 mm			
I_t	=	2.164e+08 mm ⁴			
I_w	=	1.470e-04 mm ⁶			

Shear resistance, 1-1 - Part 1-1:6.2.6, 6.2.8
 LC: '1.50*Bending', x = 0 mm
 Class_N = 1; Class_{M1} = 1; Class_{M2} = 1;
 $V_{1,pl,Rd} = \frac{A_{1,v} \cdot f_y}{\sqrt{3} \cdot \gamma_{M0}} = \frac{5546 \cdot 275}{\sqrt{3} \cdot 1.00} = 880.51 \text{ kN} \quad (6.18)$
 $V_{1,pl,T,Rd} = 1 - \frac{T_{1,Ed}}{\{f_y / \sqrt{3}\} / \gamma_{M0}} = 1 - \frac{0.00}{\{275 / \sqrt{3}\} / 1.00} = 880.51 \text{ kN} \quad (6.28)$
 $\frac{V_{1,Ed}}{V_{1,pl,T,Rd}} = \frac{0.00}{880.51} = 0.00 \leq 1.00 \quad (6.25) - \text{OK}$

 The exported .html file can be displayed properly only in web browsers supporting MathML. Currently: Firefox 38 or higher, Safari 8 and 9, iOS Safari 8.4 or higher.

The result of the XHTML exportation is a .html file and also a folder, which contains elements of the html page.

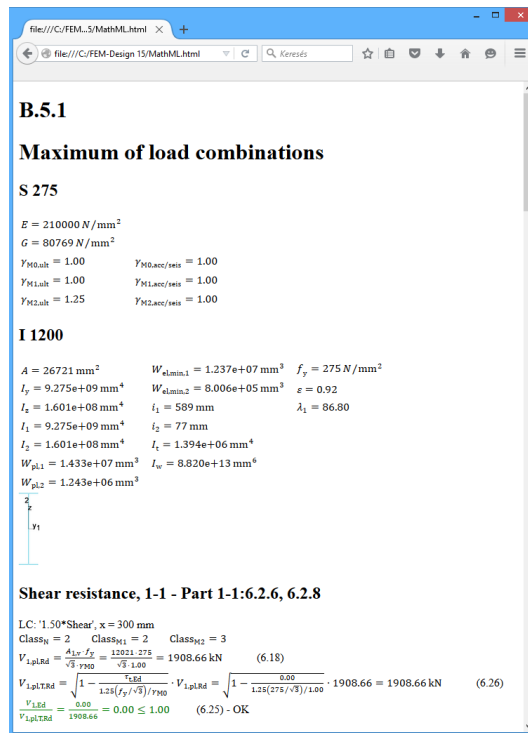

The result of the exportation to Mathcad is a single .xmcd file, which is fully editable in Matchcad 15.

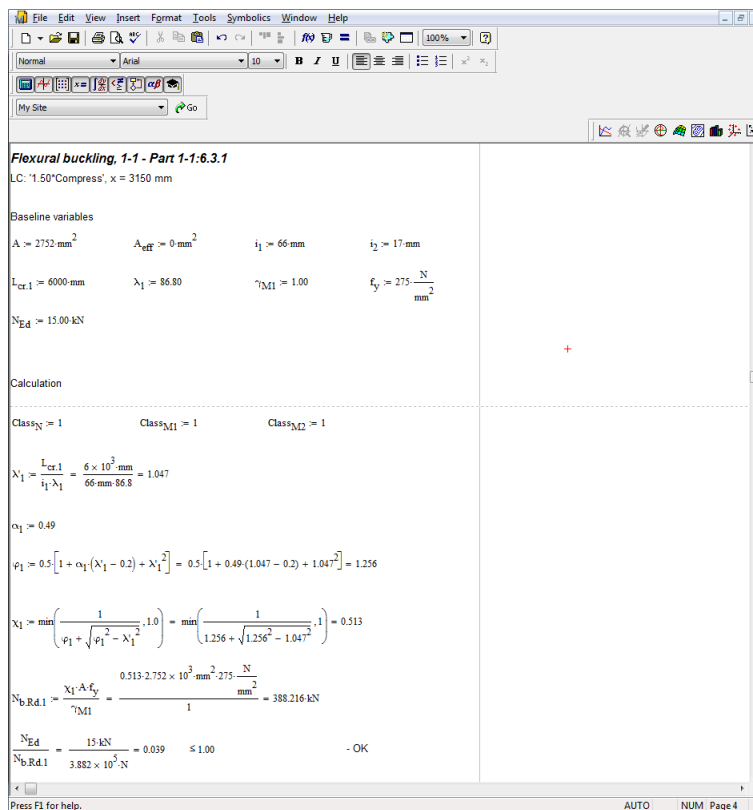

 Mathcad 15 M20 version is required to open the .xmcd file.

7.3. New and modified Lists

7.3.1 Moving load results

User can create tables of the results of the moving loads. The method is similar to the generation of the Maximum of combinations tables with one exception: User have to select also the Moving load of which result will be listed.

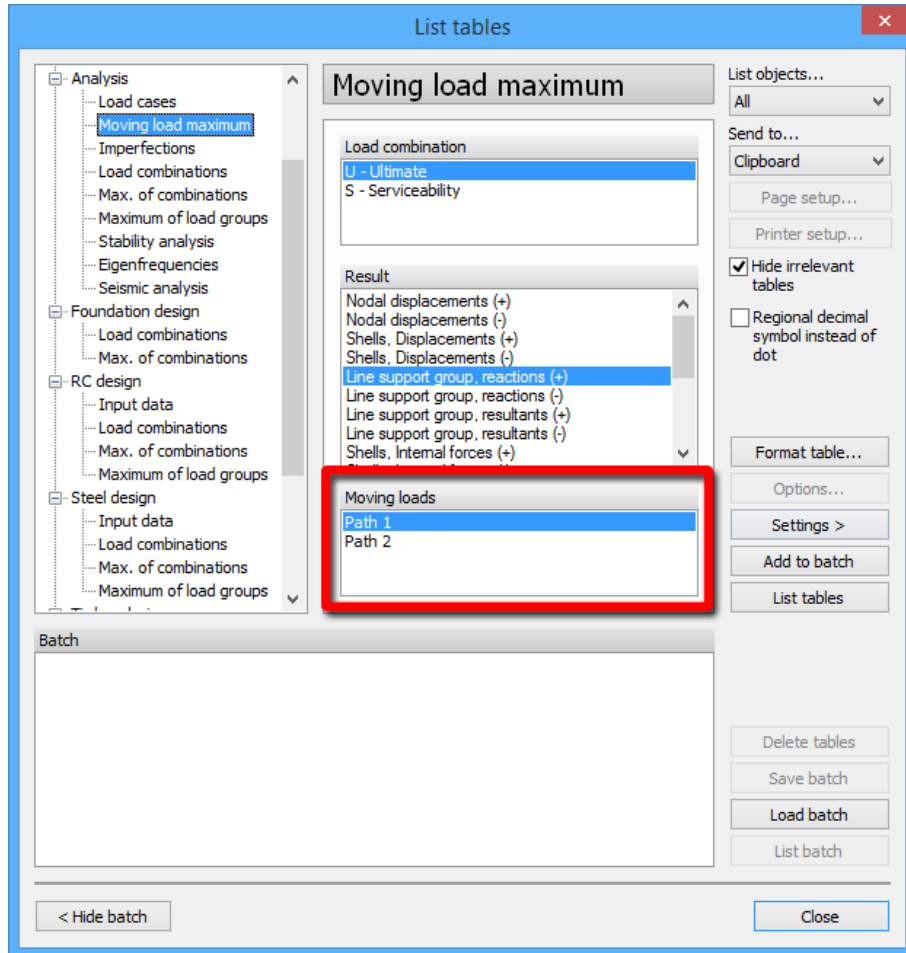

The result of the example above in MS Office Excel:

A													B	C	D	E	F	G	H	I	J	K	L	M
Moving load maximum, Line support group, reactions (+), Ultimate - Path 1													Elem	Max.	Fx'	Fy'	Fz'	Mx'	My'	Mz'	Fr	Mr	Node	Case
[-]													[-]	[-]	[kN/m]	[kN/m]	[kN/m]	[kNm/m]	[kNm/m]	[kNm/m]	[kN/m]	[kNm/m]	[-]	[-]
1	741	Fx'	0.000	-0.000	-0.000	-0.000	-0.000	0.000	0.000	0.000	0.000	1	Path 1-12											
		Fx'	0.000	-0.000	0.000	-0.000	0.000	0.000	0.000	0.000	0.000	3	Path 1-12											
		Fx'	0.000	-0.000	0.000	-0.000	-0.000	0.000	0.000	0.000	0.000	0	Path 1-12											
		Fy'	-0.000	0.003	-0.000	-0.000	-0.000	0.000	0.003	0.000	0.000	1	Path 1-7											
		Fy'	-0.000	0.003	0.000	-0.000	0.000	0.000	0.003	0.000	0.000	3	Path 1-7											
		Fy'	-0.000	0.003	0.000	-0.000	-0.000	0.000	0.003	0.000	0.000	0	Path 1-7											

7.3.2 RC shell design results

New RC shell design results can be listed, such as:

- Input data:
 - Applied reinforcements
- Load combinations, Max. of combinations and Maximum of load groups:
 - Design forces
 - Required reinforcement
 - Missing reinforcement
 - Shear capacity
 - Crack width

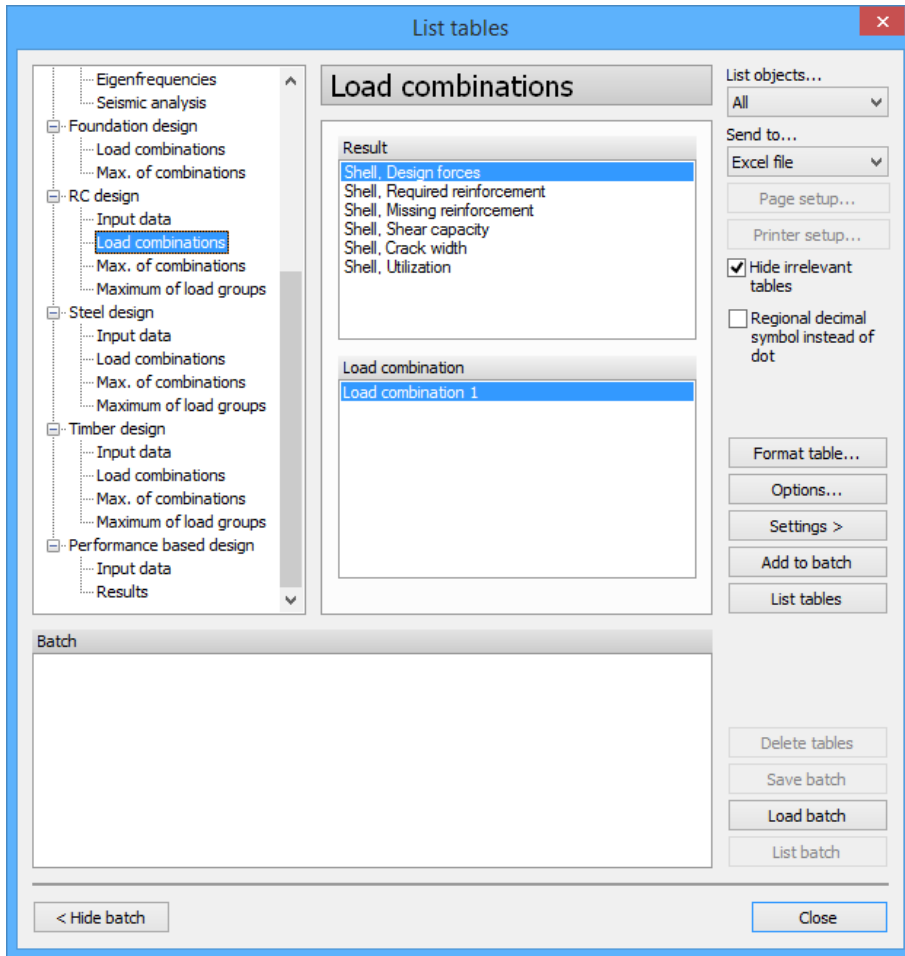

The result of the example above in MS Excel:

A	B	C	D	E	F	G	H	I	J	K
Shell, Design forces, Load comb.: Load combination 1										
ID	Elem	Node	mx or mr bottom	my or mt bottom	mx or mr top	my or mt top	nx or nr max.	nx or nr min.	ny or nt max.	ny or nt min.
[-]	[-]	[-]	[kNm/m]	[kNm/m]	[kNm/m]	[kNm/m]	[kNm/m]	[kNm/m]	[kNm/m]	[kNm/m]
P.1.1	1	870	22.437	12.259	0.000	0.000	-0.121	0.019	-0.121	0.019
	2	873	23.784	19.516	0.000	0.000	-0.121	0.022	-0.121	0.022
	3	1031	16.430	1.019	0.000	-0.030	0.016	0.033	-0.041	-0.024
	4	1203	0.000	0.000	-26.124	-8.498	0.168	0.148	-0.124	-0.144

8. CAD/USER INTERFACE

8.1. "No snap" option for layers

FD 15 gives the User the opportunity to exclude entire drawing layers from the snapping on its objects. Applying this function can be set by selecting the certain Layer in the Layers dialog and checking the "No snap" box.

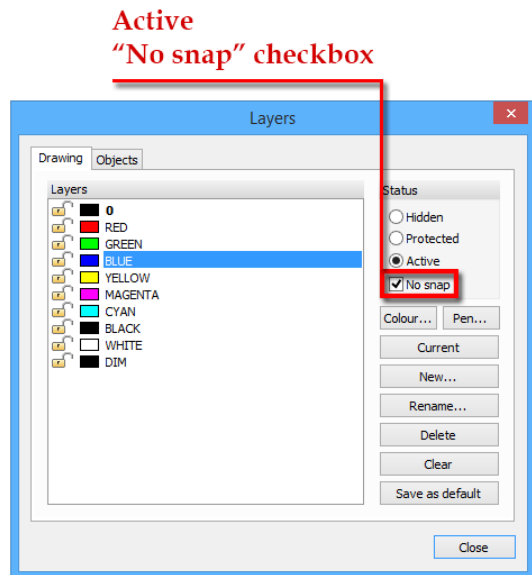
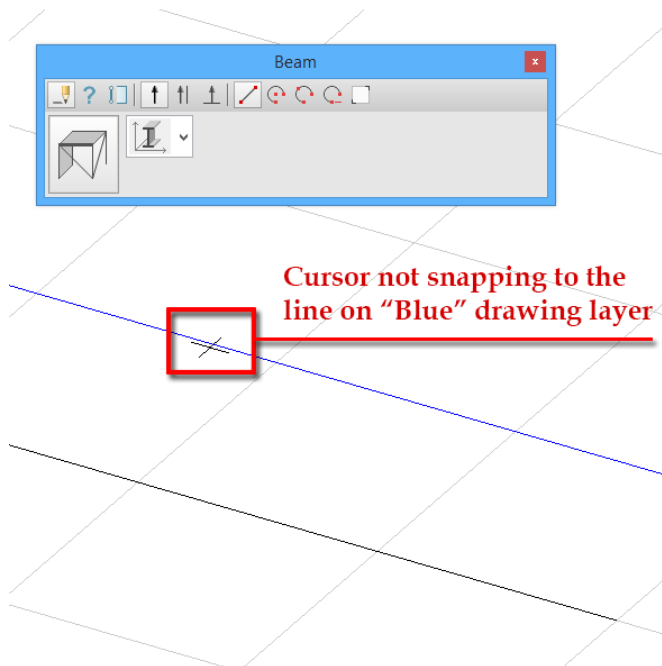
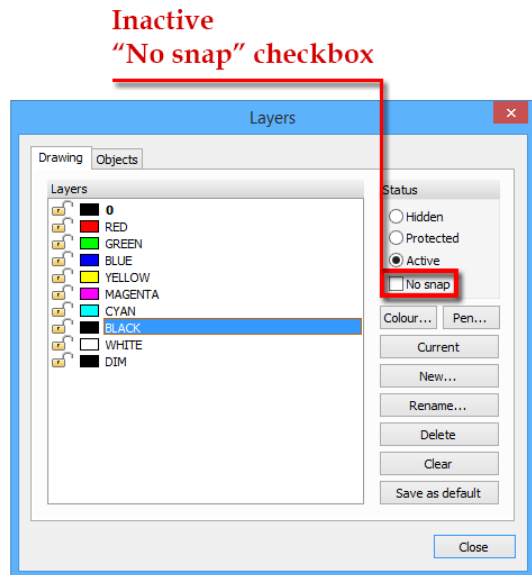
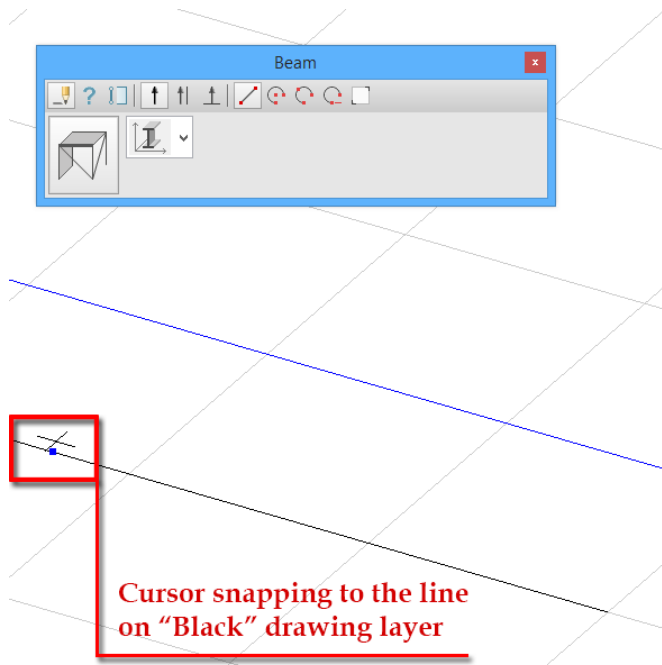



This option can be very useful while working with a model containing geometry imported from a CAD software.

8.2. More comfortable 2D and 3D view definition

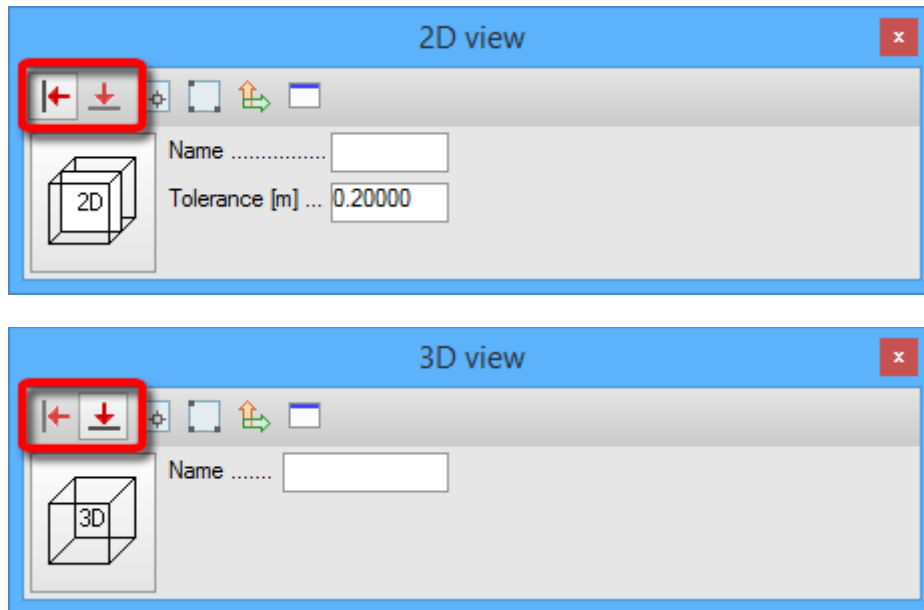
Creating 2D and 3D views became much easier with the two new tools.



-  Vertical plane: defines a view plane parallel with the global Z axis
-  Horizontal plane: defines a view plane perpendicular to the global Z axis

The method of creating 2D or 3D views are the same with these tools, shown in the following two figures.

For vertical views:

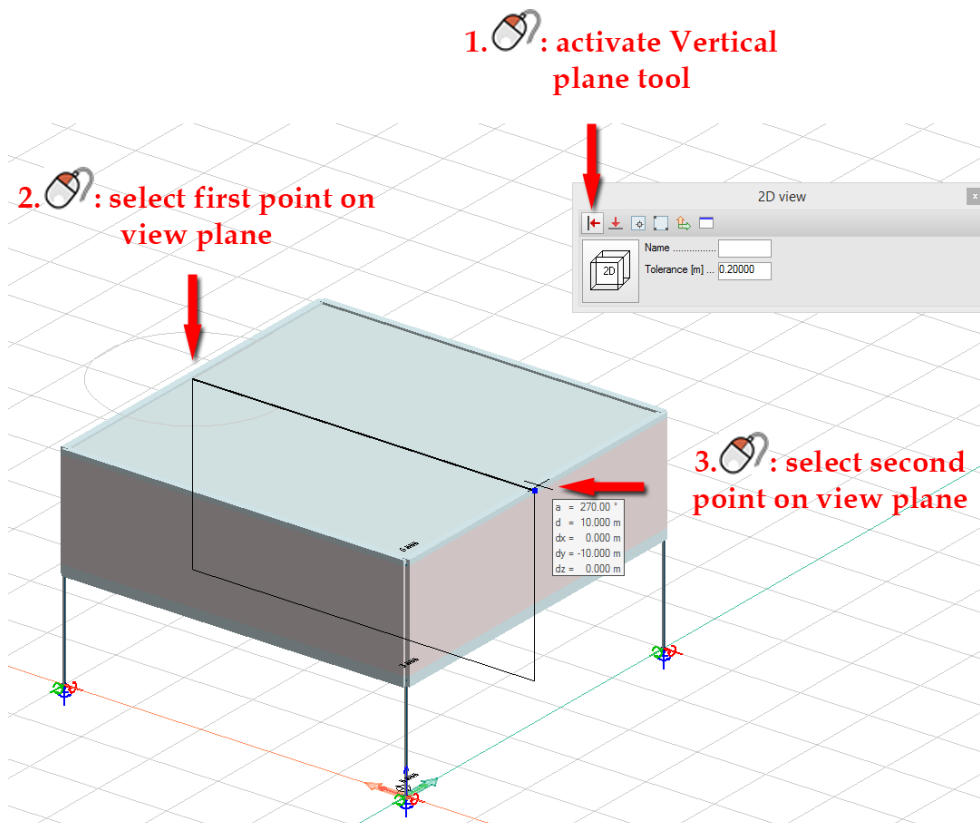

For horizontal views:

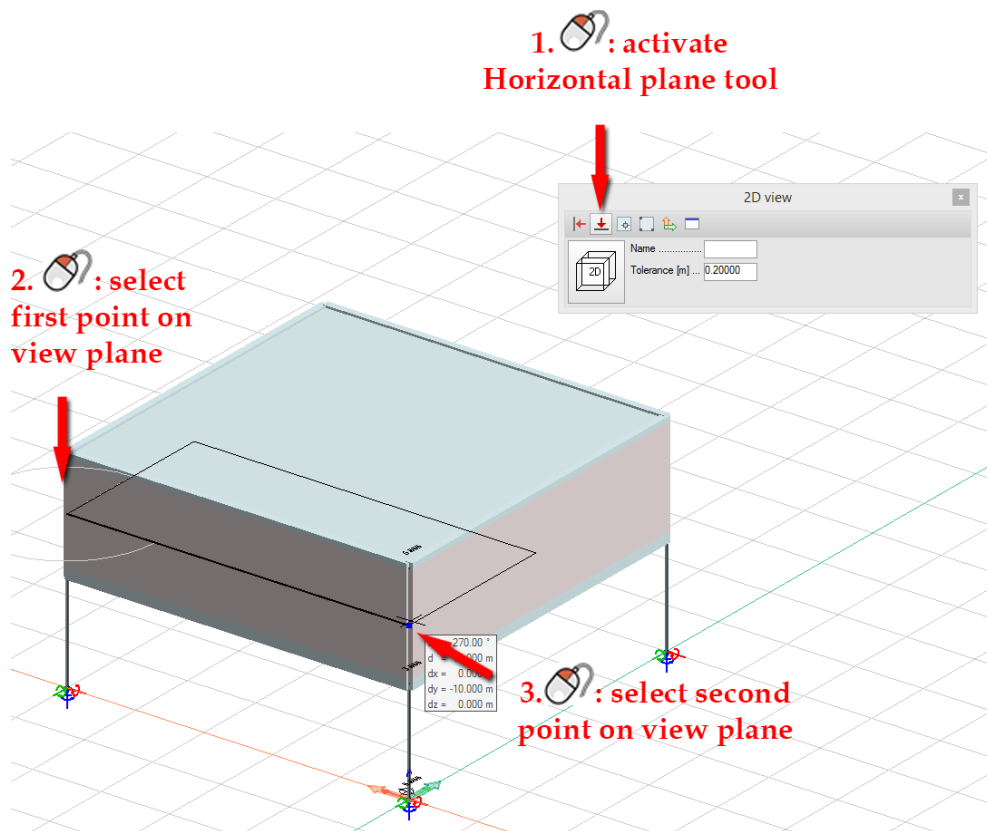

8.3. Copy from Used material/section to Library

In the new version User can copy a Used material/section of a model to the Material/Section Library. In this way they can be used in other models, too.

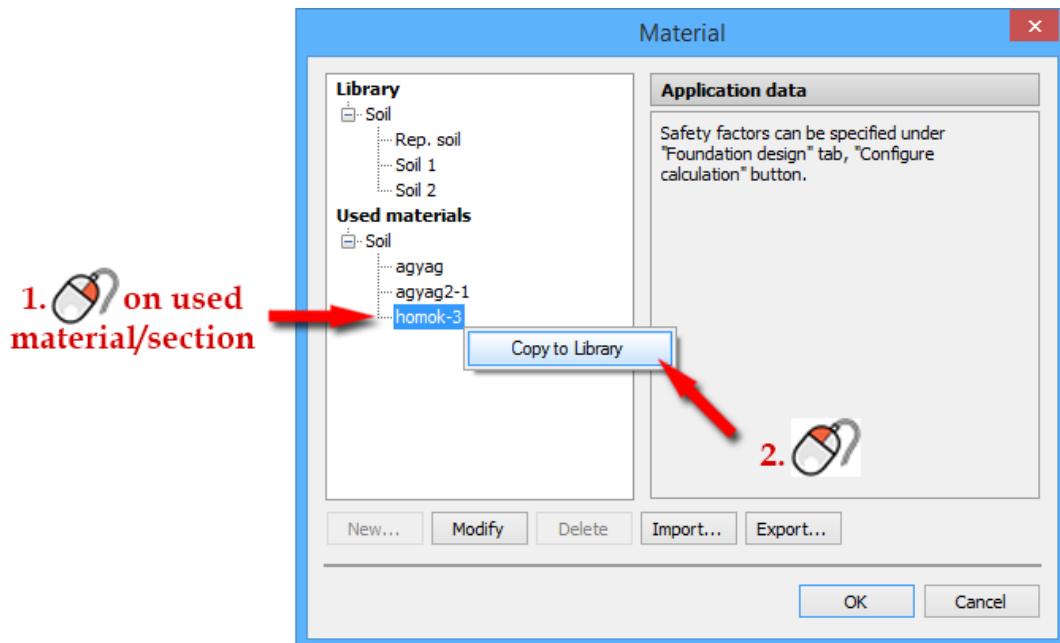

8.4. Calculation dialog staying open

In FEM-Design 14 the Calculation dialog closes after finishing the calculations, and the FEM-Design – Information dialog opens showing the Total calculation time.

In FD 15 Calculation dialog stays open (Information dialog does not appear) and displays the steps of the process and the total calculation time.

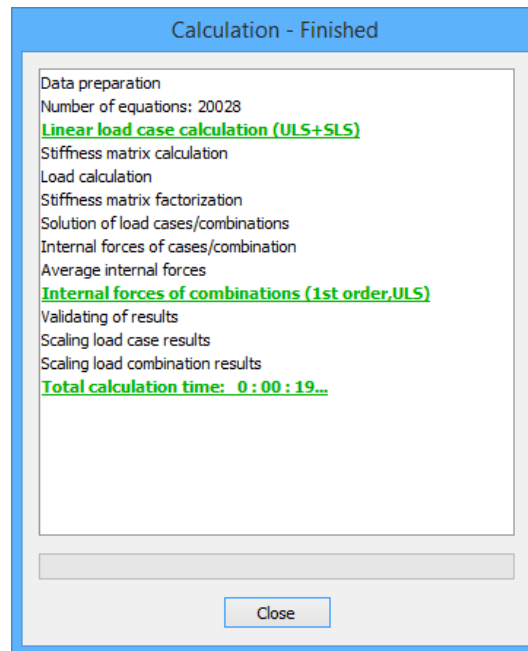

9. TOOLS

9.1. Renewed Statistics dialog

The improved Statistics dialog is more detailed than in the earlier versions, containing twice as many elements as in FEM-Design 14.

